

Smappee

EV Base Ultra

Installation manual

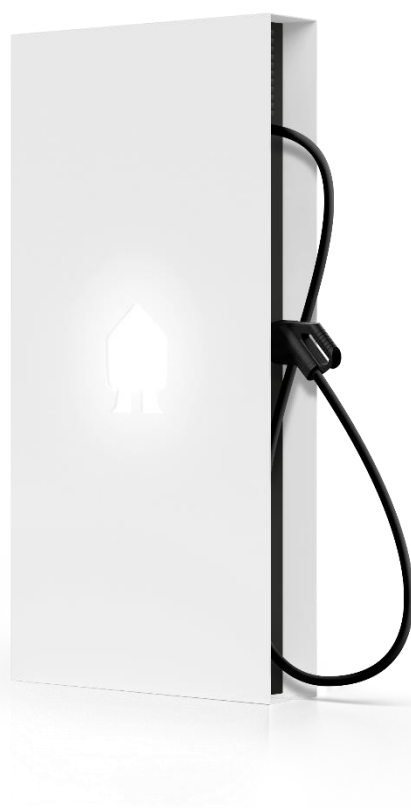

Table of contents

1. Introduction	3
2. Safety instructions.....	4
3. Models	5
4. Components.....	6
5. Technical specifications.....	8
6. Preparing the installation	10
7. Installation and activation	12
8. Maintenance	31
9. Using the EV Base Ultra.....	32
10. Declaration of conformity	36

1. Introduction

Thank you for purchasing this Smappee EV Base Ultra charging station for electric vehicles, the smartest DC charging station for businesses.

This installation and user manual tells you how to install and use the Smappee EV Base Ultra. We advise you to read the contents of this manual carefully, to ensure a safe and proper installation and enable you to use all the advanced features of this product to the full.

Support

Only qualified electricians or equivalent may install the Smappee EV Base Ultra. If you have any questions, please contact your service partner.

Please have the following information ready to hand to speed up the process: Article number and serial number which you can find on the identification label of the charging station.



Should your local distributor be unable to help you, or you have a suggestion for us, you can contact Smappee at: **support@smappee.com**.

Smappee n.v.
Evolis 104
8530 Harelbeke
Belgium

2. Safety instructions

Safety warning

Fully read and follow the safety instructions below before you install, service or use your Smappee EV Base Ultra. The installer must ensure that the charging station is installed in accordance with the relevant national and local regulations.

Carrying out activities on this charging station without the relevant knowledge and qualifications can lead to serious accidents and death. Only carry out tasks for which you are qualified and have been fully instructed.

Incorrect installation, repairs or modifications can result in danger to the user and may void the warranty and liability.

Safety precautions

	CAUTION: Risk of electric shock.
	CAUTION: Refer to the accompanying documentation whenever you see this symbol.

Please observe the following safety precautions to avoid potential electric shock, fire, or personal injury:

- The charging station is intended exclusively for charging electric vehicles and, when installed correctly, may be used by untrained individuals.
- Switch off electrical power supply to your charging station before installation or maintenance work.
- Do not use the charging station if damaged / defective.
- Do not immerse the charging station in water or any other liquids.
- Do not expose the charging station to heat, flame or extreme cold.
- Do not attempt to open, repair, or service any parts. Contact Smappee or your service partner for further information.
- Only use the charging station under the specified operating conditions.
- Do not allow children to operate a charging station.
- When a charging station is in use, adult supervision of any children present is required.
- While charging the charging cable must be completely unwound and connected to the electric car without overlapping loops. This to avoid the risk of overheating the charging cable.

Keeping order

- After charging, store the charging cable properly so it does not present a tripping hazard.
- Make sure the charging cable cannot become damaged (kinked, compressed or driven over).
- Do not place any objects on the charging station.

3. Models

Article no.	EAN	Description
EVBU-200-CCS3R	5425036933767	Smappee EV base Ultra 200S
EVBU-80-CCS3R	5425036933873	Smappee EV base Ultra 80S

4. Components

Components included

200 kW version

- 1x EV Base Ultra 200S
- 1x Charging cable CCS 250A 3.25m
- 5x Inverter 40 kW
- 1x Mounting anchor

80 kW version

- 1x EV Base Ultra 80S
- 1x Charging cable CCS 250A 3.25m
- 2x Inverter 40 kW
- 1x Mounting anchor

Article codes

Article no.	EAN	Description
EVBU-CNV40-1	5425036933774	EV Base Ultra Inverter 40 kW
EVBU-ANCHOR	5425036933828	EV Base Ultra Mounting anchor
EVBU-CBL-CSS250-3	5425036933842	EV Base Ultra Charging Cable CCS 250A 3.25m

Identification label

The identification label of your charging station is located near the emergency stop button, on the bottom of the front panel.



Art. No.:

Construction date : DD/MM/YYYY

S/N: XXXXXXXXX

Protection degree : IP 54

Main power : 400V 3P+PE (max 300A)

Max. DC output current : 400A

Max. DC output voltage : 1000V

Op. temp. : -25°C to 40°C (50°C with derating)



Made in Belgium by Smappee
www.smappee.com

5. Technical specifications

Feature	Description
Nominal input	
Power supply	3P + PE
Rated voltage (U_n)	400 Vac \pm 10%
Rated frequency (f_n)	50 Hz
Nominal input current	300 A
Power factor	>0.98 at full capacity
Efficiency	95% at full capacity
Connection method	AC, permanently connected
DC output	
Charge mode	Mode 4 (IEC 61851)
DC Plug	CCS2
Connection case	Case C (fixed cable)
Maximum current	400 A
Voltage	100 V – 1000 V
Nominal power	200 kW at 500 V – 1000 V
Interfaces & Connectivity	
Information status	RGB LED
Session activation	Plug and Charge, Scan QR code, Swipe RFID card, Smart EV schedules
Connectivity	Ethernet 100BASE-T LTE Cat M1 (4G)
Communication protocol	OCPP 1.6 JSON, ready for update to OCPP 2.0
Metering	kWh meter compliant with IEC 62053-21
Certifications and Standards	
Product certification	CE
Standards	IEC 61851, ISO 15118
Environment	
Enclosure material	Magnelis
Enclosure standard colours	RAL9016 (star white) + RAL7021 (black grey)
Protection degree	IP 54
Mechanical impact protection	IK10

Pollution degree	3
Electrical safety class	I
Stand-by use	LED brightness 0%: 90 W LED brightness 100%: 100 W
Acoustic noise	0 dB – 60 dB
Environmental conditions	Indoor and outdoor use
Operating temperature	-25 °C to 40 °C (50 °C with derating)
Storage temperature	-25 °C to 60 °C
Relative humidity	0 % - 95 %, non-condensing
Maximum installation altitude	0 – 2.000 m
Access	Locations with restricted and non-restricted access
Physical properties	
Dimensions	1800 x 900 x 225 mm
Total Weight (excl. packaging)	270 kg
Front panel	31 kg
Rear panel	26 kg
Central unit	84 kg
Inverter (each)	20 kg
Charging cable	9 kg
Anchor	20 kg
Charging cable length	3.25 m
Stationary / moveable	Fixed installation
External design	Enclosed assembly
Mounting method	Floor / Ground-mounted



The operating temperature assumes the ambient temperature of a product delivered in the default enclosure colours RAL9016 (star white) + RAL7021 (black grey). Direct exposure to sunlight may have an adverse effect on the temperature range.

If the product is exposed to lower or higher ambient temperatures, continuous operation cannot be guaranteed. If temperatures exceed the maximum values, the charging station will automatically decrease the charging current to decrease the internal temperature of the charging station. This stabilises the internal temperature and makes it less likely that a transaction will be unexpectedly paused.

If the product is directly exposed to sunlight, the automated temperature management may automatically start below the maximum ambient temperature. Therefore, wherever possible, avoid exposing the charging station to direct sunlight.

Where products are exposed to the elements of nature, the enclosure can be subject to gradual aging of the material, which can result in product discolouration over time. Therefore, wherever possible, place the product in a sheltered place to optimise the life of the materials.

6. Preparing the installation

First step is to prepare the physical installation of the EV Base Ultra as described in this chapter.

Installation prerequisites

- Calculate the existing electrical load to find the maximum operating current for the charging station installation. Note that with the Smappee Overload functionality more charging stations or the total maximum operating current can be higher than the physical installation allows.
- Obtain all necessary permits from the relevant local authority.
- Refer to local wiring regulations to select the conductor sizes and use only copper or aluminium conductors.
- Make sure that the installation area of the charging station is adequate for usability and ventilation purposes.
- Use the correct tools and provide sufficient material resources and protection measures.
- Make sure that there is an Ethernet based internet connection available for each EV Base Ultra (1 per unit). It is possible to operate the station using only its 4G connection, but this is not recommended.

Power supply

- The appropriate wire gauge of the supply cable depends on the power rating and distance between the meter cabinet and the charging station. The voltage drop must not exceed 5%. It is advisable to have a maximum voltage drop of 3 %.
- The maximum cable lug that can be fitted has a width of 32 mm.
- The power supply trajectory from the circuit breaker panel up to the EV Base Ultra charging station must be protected against short-circuiting and over-current with B or C circuit breakers (or otherwise in compliance with local standards and regulations)
- A charging station connector must always be installed on a dedicated power circuit.
- When the power supply and the charging station are part of a TN-S system, the station must be grounded via the main distributor.
- Route the power supply cables to the position where the charging station will be installed together with an Ethernet cable for the internet connection.
- Make sure the power supply cables are positioned through the central position of the EV Base Ultra anchor.
- Make sure that there is at least 30 cm available out of the ground.
- Local regulations may be applicable and can vary depending upon the region or country.



The power line enters the charging station via the floor plate.

The Ethernet cable, used for the internet connection, enters the charging station via the EV Base Ultra anchor.

The maximum power rating for each connector is specified in the table below.

Power per connector	Connection	Input current	Output current
200 kW	3-phase	3 x 300 A	DC 400 A

Tools (not included)





- Screwdrivers
- Hex key set
- Multimeter and earth ground meter
- Wire stripper and cutter.
- Needle-nose pliers.
- Cable lugs with a maximum width of 35 mm
- 17 mm socket wrench with ratchet handle

Supplies (not included)

- Ethernet cable and RJ45 connector for wired communication.
- Power supply cables

7. Installation and activation

This procedure describes the required steps for the physical installation of the EV Base Ultra.

	CAUTION: The installation must be carried out by a qualified professional who has read this manual and works in compliance with IEC 60364 standards. Neglecting this may lead to severe injuries or hazardous situations while working with electricity.
	CAUTION: The electric system must be entirely disconnected from every power source prior to performing installation or maintenance work. Make sure it is not possible to connect the electric current during installation. Put up caution tape and warning signs to mark the work areas. Make sure no unauthorised people can enter the work areas.
	CAUTION: Hazardous electrical voltages are present in the EV Base Ultra (up to 1000V)
	CAUTION: The charging station contains electric components that may still contain electrical charge after being disconnected. Wait at least 10 seconds after disconnection before commencing work.
	CAUTION: Adaptors or conversion adaptors and cord extension sets are not allowed to be used.
	The EV Base Ultra contains components and circuits boards sensitive to electrostatic discharge. Sufficient ESD measures should be taken to protect the components during installation and maintenance.
	Components of the EV Base Ultra can be very heavy, for example the inverters.
	Take care that components don't squeeze a human body or body part while assembling or disassembling.

Transport, storage and unboxing the EV Base Ultra

Transport and storage

- Disconnect electrical power supply before removing the charging station for storage or relocation.
- Only transport and store the charging station in its original packaging. No liability for damage incurred will be accepted if the charging station is transported in non-standard packaging.
- Store the charging station in a dry environment within the temperature range specified in the technical specifications.

Unboxing

The charging unit, charging cable, inverters and anchor are delivered in separate boxes. Make sure to use the proper equipment or enough people to move the different components.

Especially the charging unit and inverters need more than one person to lift.

Unboxing the different components doesn't need special attention. Just keep in mind to store the cardboard, as this can be used to safely store the front and back panel while installing the EV Base Ultra.

Assemble the EV Base Ultra anchor

The Smappee EV Base Ultra is designed to be installed at ground level using the supplied anchor.

It is mandatory to use this anchor.

In order to guarantee compact transportation, the anchor is supplied in a kit and needs assembling. To separate the parts, first remove all nuts holding the different parts together.

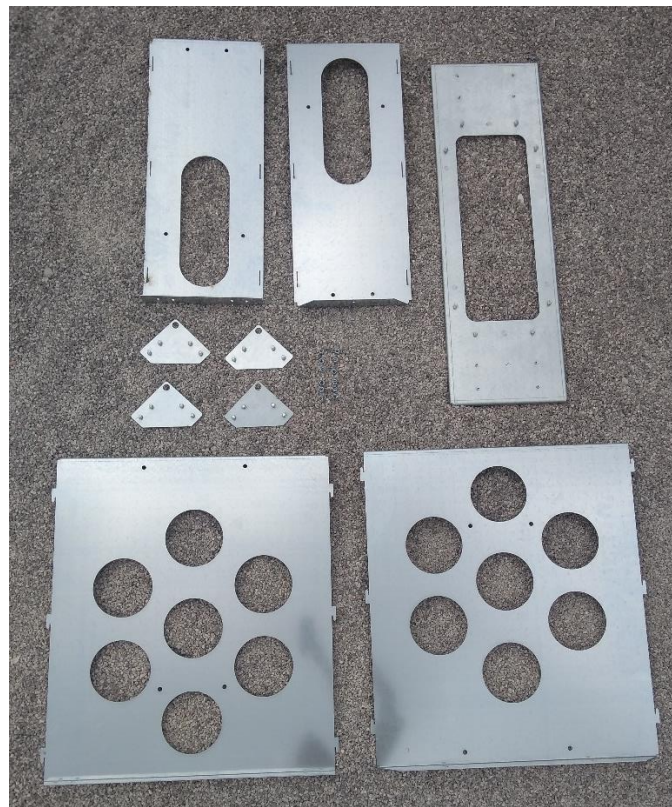
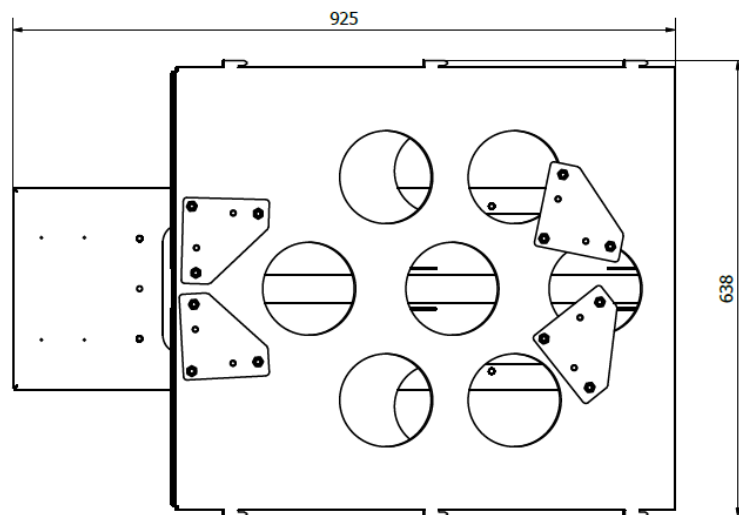

The dimensions of the assembled anchor are as followed.

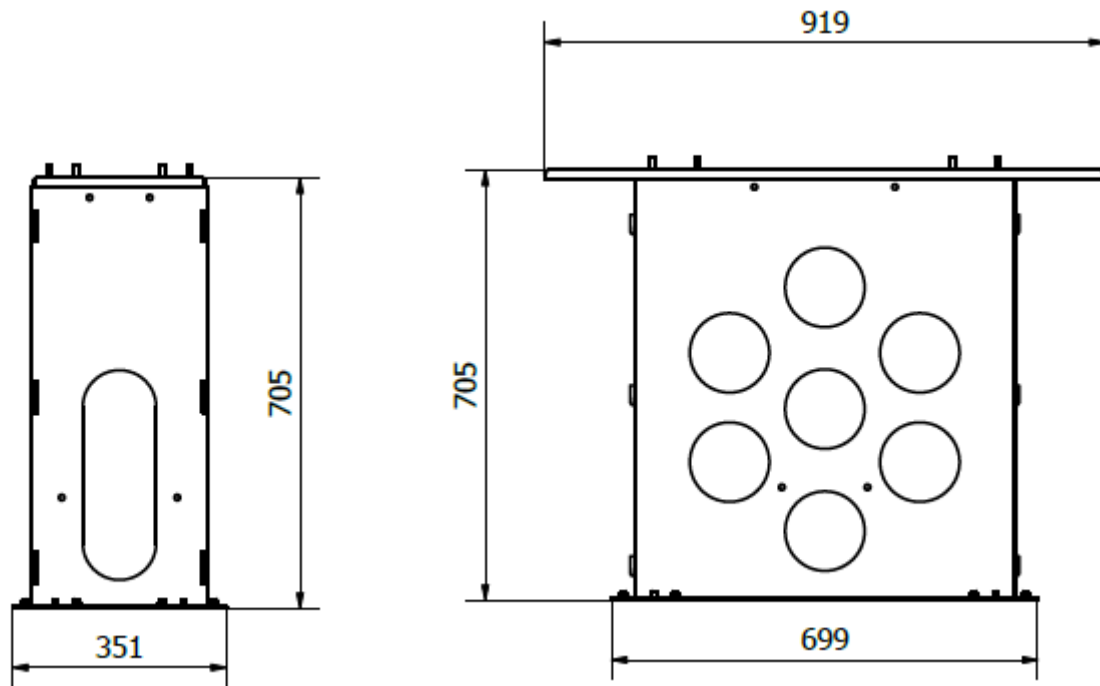

Follow these instructions to assemble the different parts:

- Take one side panel, one front panel and two mounting corners.



- Join the front and side panel using the grooves and place the joined panels over a mounting corner.

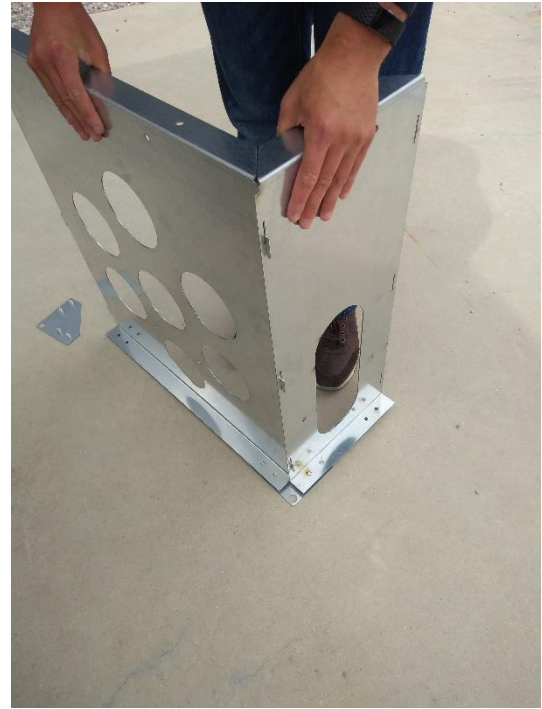
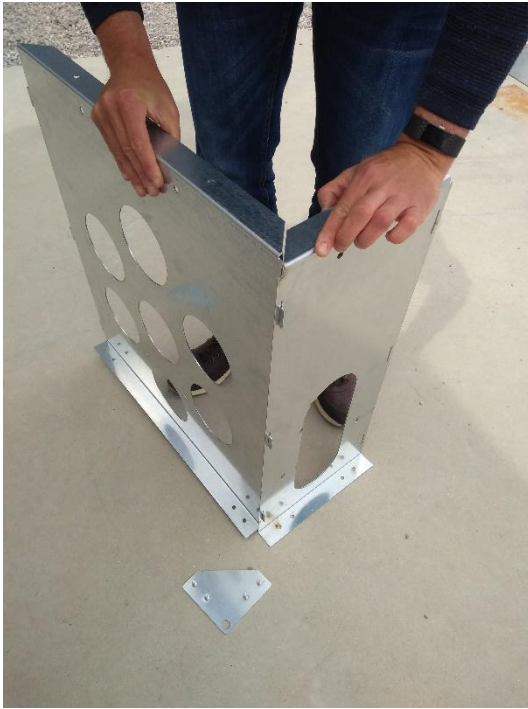

- Take the second side panel and place this in the same position as the other side panel. Use the grooves to join the side panel to the front panel.



- Take the last front panel and use the grooves to mount the panel to the two side panels.

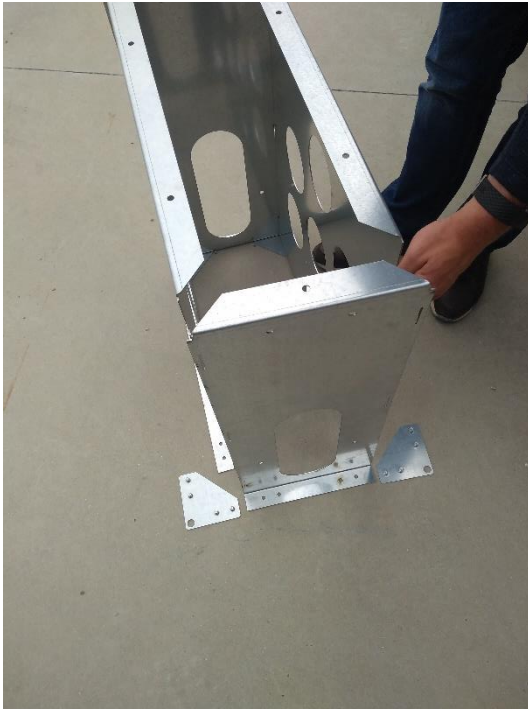

- This makes sure the four panels are joined together. They still need to be secured using the mounting corners. Carefully tilt the anchor to slide the mounting corners into position. The mounting corners can be fixed by hand tightening the supplied nuts.



Do NOT torque the nuts yet. This is done during the last step of the assembly.

- Place the cover plate on the anchor and secure with the supplied nuts using a socket wrench.

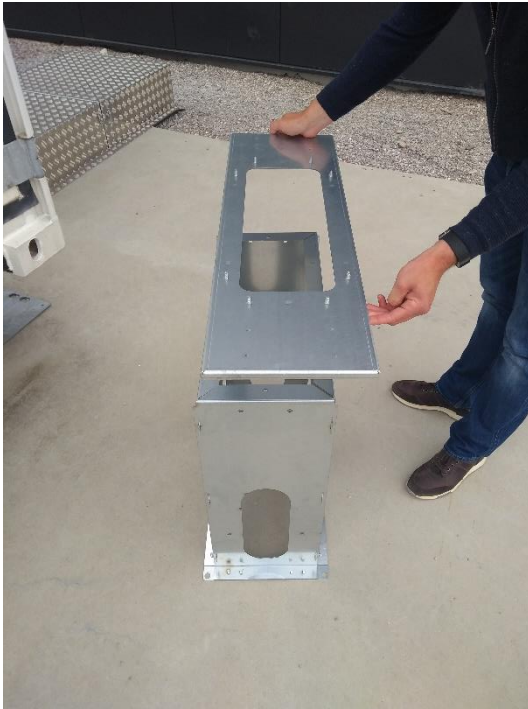

- Finally, the nuts of the mounting corners can be tightened with a socket wrench.



- The EV Base Ultra anchor is now ready to be mounted and to host the charging station.



Mount the EV Base Ultra anchor

A stable and level ground needs to be prepared in advance. We advise a levelled concrete foundation at ground level minus the height of the anchor. It is also possible to have the foundation a little lower. This allows the EV Base Ultra to be integrated in the surrounding soil.



The EV Base Ultra can be placed maximum 3 cm below the top of the surrounding soil for aesthetic purposes. It cannot be placed lower as there will be risk of water ingress.

To correctly install the EV Base Ultra anchor:

- a. Create a foundation made of a dry mixture of sand and cement. The minimum dimensions of this foundation are 450mm by 750mm. This is a bit larger than the dimensions of the anchor, to make sure a stable foundation is created.
- b. Reinforce the corners of the foundation using a concrete block.

- c. Make sure the concrete blocks are level in both directions. If not, adjust until level.
- d. Place the EV Base Ultra anchor on the concrete blocks. If needed, the position of the anchor is fixed by pushing a hub through the holes in the corner.



- e. Route all necessary cables through the anchor. This includes power supply, ground and ethernet cables.
- f. Fill the anchor with concrete until half of the anchor is filled with concrete. It is normal that some excess concrete pours out of the holes. Use this excess to further fix the anchor to the foundation.
- g. Wait for the concrete to cure before going to the next steps.

The EV Base Ultra anchor is now secured in place and ready for the EV Base Ultra to be mounted.

Place the EV Base Ultra on the anchor

- a. While the EV Base Ultra is in the cardboard box, first remove the backplate of the EV Base Ultra. The back plate is the one without the Smappee avatar. This removes some weight from the charger and provides extra grip.
Remove the backplate of the EV Base Ultra by unscrewing the 12 screws (using a 5 mm hex screwdriver) and put it in a safe location where it cannot be scratched or damaged otherwise; for instance in the packaging of the EV Base Ultra.

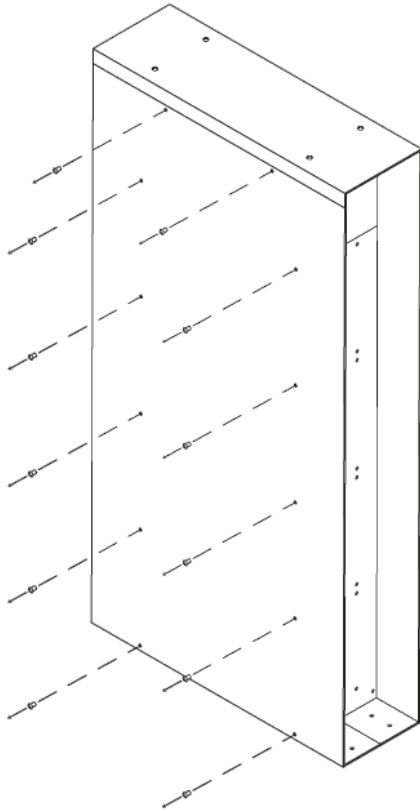

- b. Put the EV Base Ultra in an upright position. By tilting the EV Base Ultra back and forwards, the cardboard is removed underneath the charging unit.
- c. Remove the front plate of the EV Base Ultra by unscrewing the upper 4 screws (using a 5 mm hex screwdriver). After unscrewing the 4 screws, the front plate can be removed by lifting and moving it forward. Put it at a safe location where it cannot be scratched or damaged otherwise; for instance in the packaging of the EV Base Ultra.

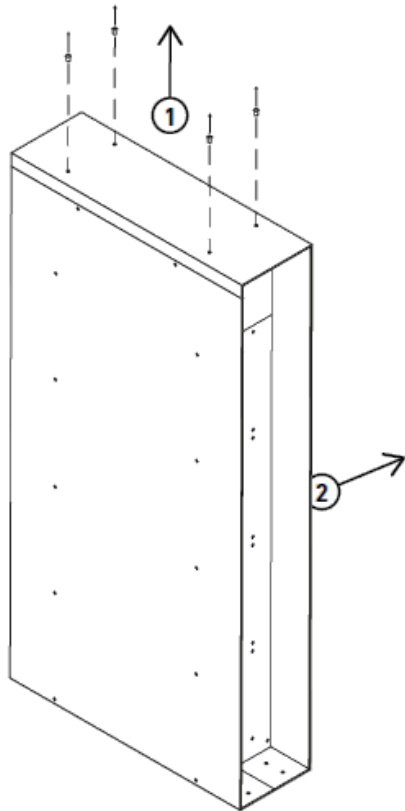

- d. A top plate of the EV Base Ultra anchor is already mounted to the charging unit for easy installation. In order to place the EV Base Ultra on the installed anchor, first remove the dummy top plate of the installed anchor.

Leave the top plate mounted to the charging station as is.



- e. Place the EV Base Ultra (with floor plate) over the anchor. Make sure all holes align with sides of the anchor and the power supply and ethernet cables go through the central opening of the EV Base Ultra.



- f. Use the supplied nuts to secure the EV Base Ultra to the anchor. Tighten the nuts using a socket wrench.



Power supply connection

TN-C grid

In a TN-C grid, a combined PEN conductor fulfils the functions of both a PE and an N conductor. This means only 4 conductors are needed for this type of installations: 3 phases and 1 (PEN) ground cable.

The internal wiring of the EV Base Ultra assumes a TN-C grid by default. Reason why a connection is made between the neutral and ground connection.

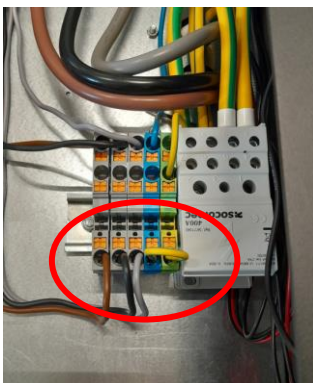

Use cable lugs with a maximum width of 35 mm and connect phase 1, 2 and 3 to the load break switch. The screws should be tightened with a torque of **40 Nm**.

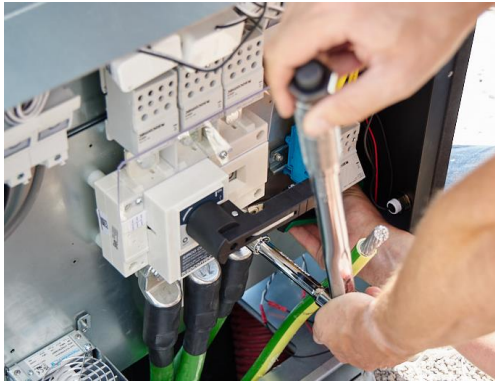

Protect the power supply cables using the plastic cover of the load break switch.



Connect the ground to the distribution block on the right of the EV Base Ultra, using an 8 mm hex wrench. Tighten it to **25 Nm**.



TN-S grid

In a TN-S grid, the PE and N are separate conductors that are connected together only near the power source. This means that besides the conductors for the power supply of the EV Base Ultra, an extra 5G2.5mm² cable is needed.

Remove the pre-wired cable from both the distribution block and the connecting block

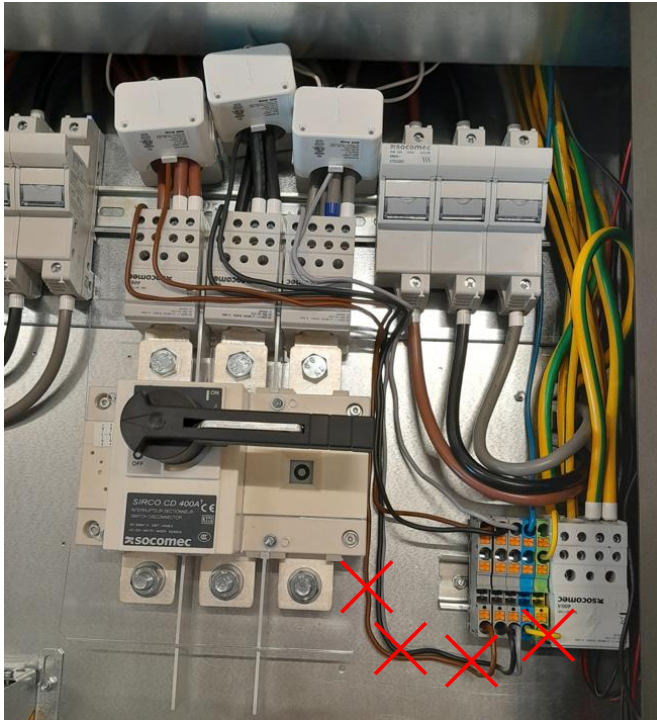

The picture below shows the situation after removing the pre-wired cables:

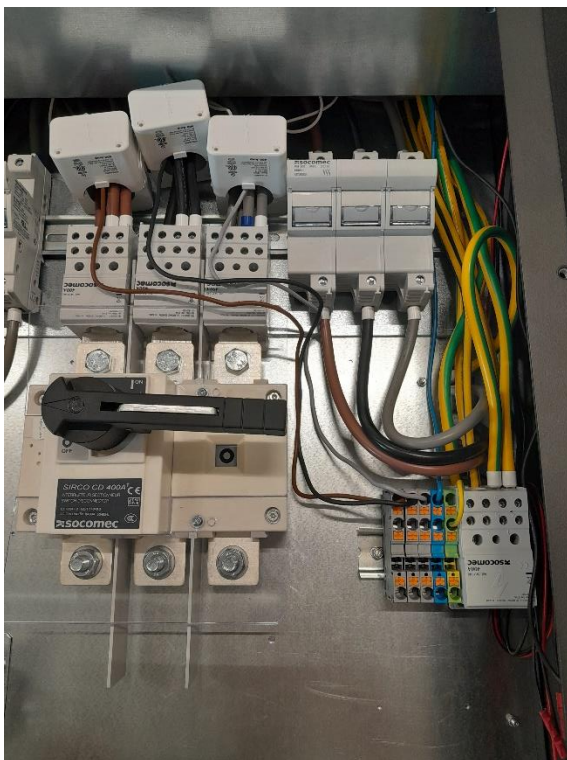

Mount the 5G2.5 mm² cable to the connecting block, respecting the colour assignment. The 5G 2.5mm² cable is secured with a 20A circuit breaker in the distribution panel.

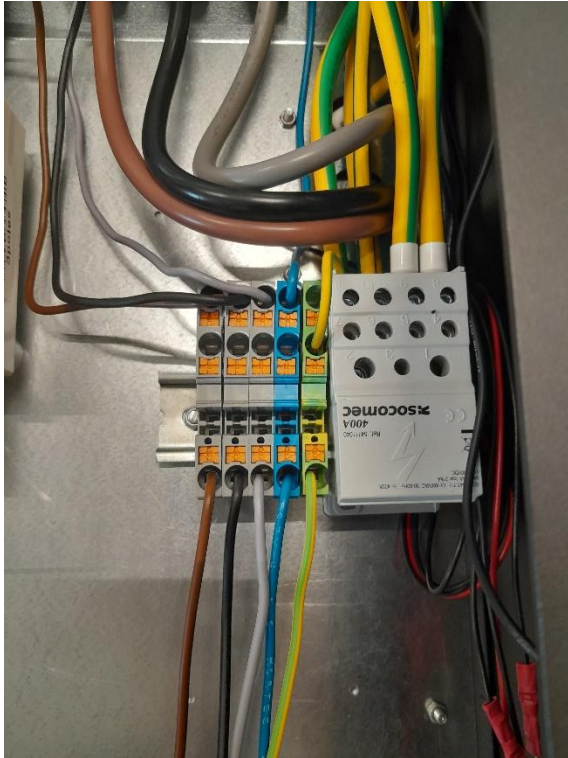

After removing the pre-wired cable and installation of the 5G 2.5mm² cable, the installation of the power supply cables is the same as for a TN-C grid.

Use cable lugs with a maximum width of 35 mm and connect phase 1, 2 and 3 to the load break switch.

Connect the ground to the distribution block, just like in a TN-C grid.

Mount the inverters

The EV Base Ultra is supplied with five inverters for the 200 kW version or 2 inverters for the 80 kW version. Each inverter slides into a foreseen slot. There are four slots in the back and one in the front.

In order to access the middle inverter slot on the front, first remove the metal beam holding the RFID reader. To do this, use a 2.5mm hex wrench.



The inverters in the back have the DC output at the bottom of each slot, while the inverters in the front have the DC output at the top.

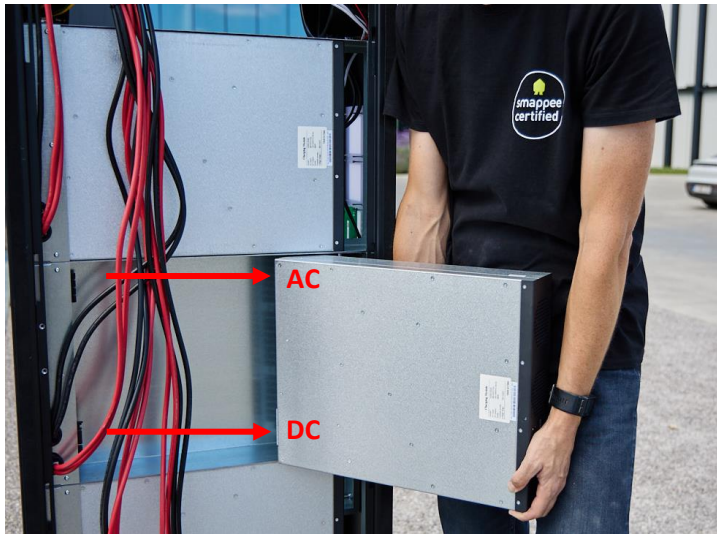

The inverter is into position when the right side of the inverter touches the right side of the slot.

After mounting the inverters, remount the metal beam with the RFID reader.



EV charging cable mounting

In order to prevent damaging the CCS2 connector, it is advised to plug the socket into the cable holder before starting to mount the charging cable.



Route the charging cable through the cable gland and connect ground (green/yellow), plus (red) and minus (black) to the corresponding distribution blocks using an 8 mm hex wrench. Tighten these connections to **25 Nm**.



The remaining six control cables have a label from 1 to 6. Mount each cable to the corresponding connector within the EV Base Ultra. Use a small screwdriver to connect the cable.

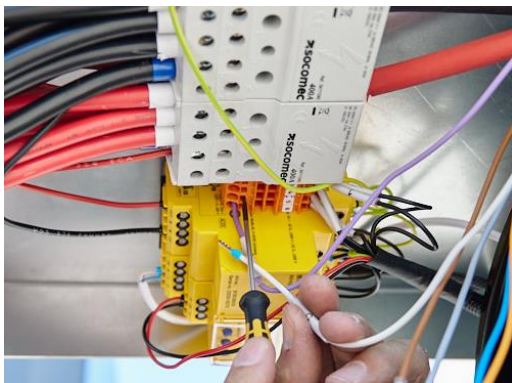

Internet connectivity

An Ethernet cable should be used to provide network connectivity for the EV Base Ultra. This Ethernet cable is mounted in the open RJ-45 LAN port of the Teltonika router.

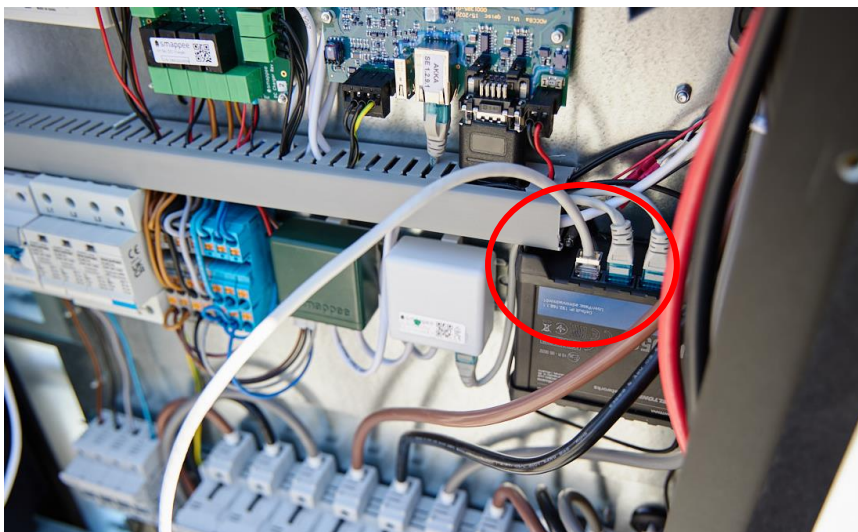

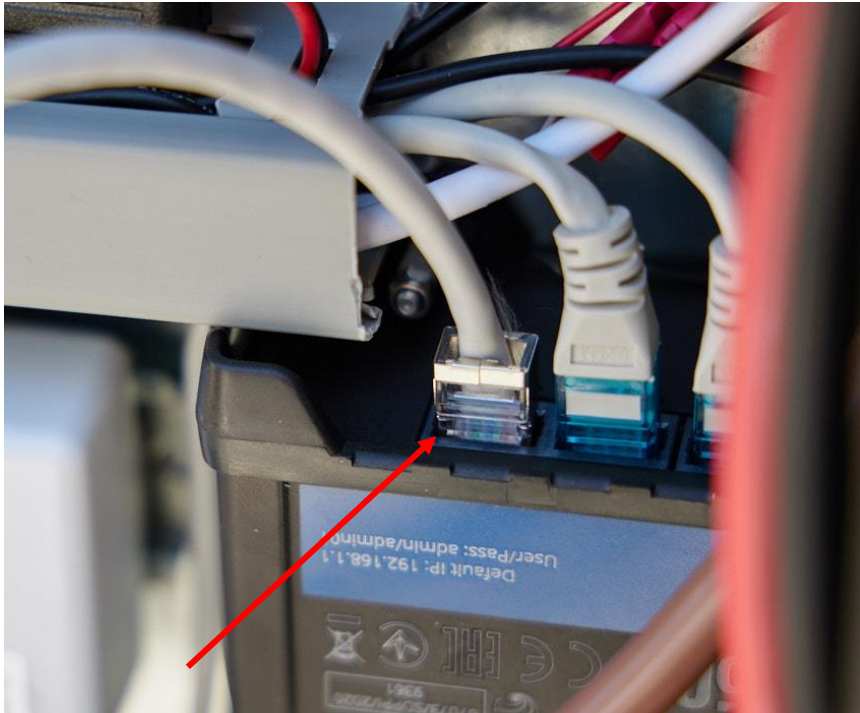

The Teltonika router creates a small, private network within the EV Base Ultra to provide network connectivity for all components. This private network is created within the subnet 192.168.37.0.

Each Teltonika router is configured with a 4G connection as backup in case of failure of the wired Internet connection.

Switch on the EV Base Ultra

Before switching on the EV Base Ultra, make sure no tools are near any power supply connections and people stand free of the EV Base Ultra.

After switching on the EV Base Ultra, wait for approximately 30 seconds to verify the following LED indicators:

- Connect gateway – Blue blinking (1x per second)
- Power Box – Pulsing 1x per 3 seconds
- CT Hub – Pulsing 1x per 3 seconds
- Charging controller – green flashing light (1x per 3 seconds)
- Akka Board – Traffic light styled leds
- Teltonika 4G Router – Signal strength indicator
- Inverters – Green led on front panel

Activation

This procedure is done with the Smappee mobile app. You can download this from the Apple App Store for iOS or the Google Play store for Android phones.



The Smappee App will guide you through the various steps to fill in all the required information.

- Log in to the Smappee App with the corresponding Smappee username or create a new user account.
- Install a Smappee EV Base Ultra
- Follow the steps shown in the mobile app.

	Multiple charging stations can be installed at a single location. To add a new charging station in the mobile app, go to Settings > Your Smappee charging stations
	The settings of your charging station can be adjusted in the Smappee Mobile app or Dashboard.
	For overload protection or optimised self-sufficiency additional Smappee Infinity components must be installed to measure the Grid and Solar, Battery or other submetering if applicable.

Closure

- a. Fill the opening between the anchor and charging station with an airtight material such as polyurethane foam. This is to prevent the overpressure from the cooling fans escaping into the ground, and to stop small animals from entering the charging station via the ground.
- b. First place the front plate into position. Make sure the grooves align and the front plate slides into place.
Do not fix the front plate with screws at this moment.



- c. Place the back plate into position and fix with the supplied screws and 5mm hex wrench.



- d. Use four screws to fix the top of the front plate, using a 5mm hex wrench.
Front and back plate should align.

- e. To end, use 8 screws to fix the front and back plate to the floorplate of the anchor.

8. Maintenance

For safe and regular operation of the EV Base Ultra, regular maintenance or control is required. Refer to the table below for the intended maintenance work and interval. All points in the table are considered mandatory and must be carried out by a certified technician.

Before starting maintenance activities, consider all safety precautions as listed in chapter 2, Safety instructions (page 4) and **Error! Reference source not found.** Installation and activation (page 12).

Maintenance

- Observe the maintenance schedule in the table below.
- Clean the outside only with a dry, clean cloth.
- Do not use abrasive agents or solvents.
- May not be carried out during rain or if air humidity exceeds 95%.

Maintenance task	Maintenance details	Interval
Charging cable	Replace the charge cable	After 10000 charging cycles
Residual Current Devices (RCDs)	Perform a function test of the residual current devices	Every 6 months
Main switch	Verify the correct operation of the main switch	Yearly
Verification of protective measures	With the charging station switched off, check the resistance between the ground of the power supply and all externally accessible parts. This can be housing, screws and other parts.	Yearly
Check for cleanliness and condensation	Open the EV Base Ultra and check for traces of condensation and if the interior is clean.	Yearly
Ventilation filters	Replace the filters	Yearly
Visual check	Annual visual check light over voltage protection	Yearly

9. Using the EV Base Ultra

There are three ways of charging using a Smappee EV Base Ultra:

1. Plug and charge: Simply insert the connector in the EV and start charging.
2. Swipe and charge: Insert the connector, swipe your RFID card and start charging.
3. Scan and charge: Insert the connector, scan the QR code in the Smappee App and start charging.

Below you can find the different charging sequences.

	Each EV Base Ultra that is installed and activated is Plug and charge. Changing the Session Activation Method is done using the Smappee Dashboard. Changing the authentication methods can be done remotely.
	Scan and charge and Swipe and charge (with Smappee CSMS) can only be used when a Smappee Payment Agreement has been signed. Please contact your Business Developer for more info.

Plug and charge

The charging station is freely accessible without the need to authorize. Anyone can plug their car into the charger and start charging for free.

Start charging



Stop charging



Swipe and charge

Charging sessions can be started using an RFID card. You can either use a Smappee Smart Charge Card for free charging or (if activated) a third party eMSP card to pay for charging sessions.

The RFID readers are situated at the side of the EV Base Ultra, close to the connector.

- **Whitelist:** charging is free with a Smappee Smart Charge Card or any other authorized RFID card. Once the charging cable is plugged-in, the user simply swipes their RFID card and the free charging session begins. All authorized cards must first be added to the whitelist using the 'Whitelisting' card on dashboard.smappee.net. See [this](#) article for more information. Cards can be ordered via info@smappeeservices.com.
- **Public charging:** other EV drivers can use this charging station and pay with a payment card from a third-party eMSP such as Shell Recharge or Plugsurfing. This can be done through Smappee's own CPO or through a third-party CPO. In case you would like to use the Smappee CPO, please contact info@smappeeservices.com to activate this.
- **Split Billing:** This is aimed at employees who charge their company car at home and need to be reimbursed for the electricity consumption. Split billing agreements must be made for each employee. Starting a charging session is similar to whitelisting but at the end of each month, Smappee Services will send a bill for all employees' charging sessions to the company. All individual employees will be reimbursed according to the amount of kWh charged. See [this](#) article for more information. In case you would like to use Smappee split billing, please contact info@smappeeservices.com to activate this.

Start charging



Stop charging



Scan and charge

The user pays by credit card (Visa or Mastercard) using the Smappee App. They scan the QR code shown on the charging station and the app will guide them through the process of starting the charging session. It is also possible to set discount rates for specific users. Please contact info@smappeeservices.com to activate Scan and charge.

Start charging

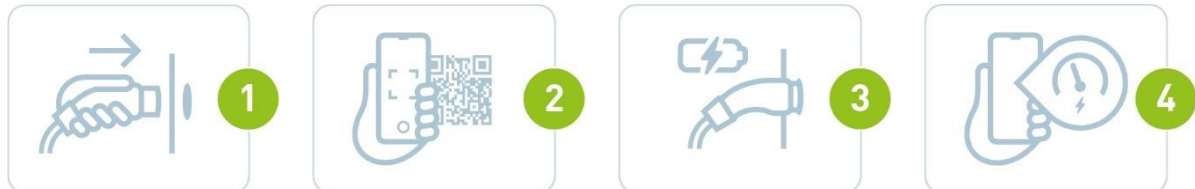







Stop charging



More information on how to use the Smappee EV Wall Business can be found on: support.smappee.com/hc > Smappee EV Line

LED status

LED colour	LED status	Meaning	Action of the user
	White continuous	The Smappee EV Base Ultra is available.	Connect your EV with the Smappee EV Base Ultra.
	Blue continuous	Your EV is connected with the Smappee EV Base Ultra, but is not yet charging.	<ul style="list-style-type: none"> • If using an RFID, scan your charge card and wait until the LED turns flashing blue. • If using QR codes, scan the QR code and wait until the LED is green pulsing. • If no authorisation is required, wait until the LED becomes green pulsing.
	Blue flashing	Your RFID card is being verified.	Wait until the LED is green pulsing.
	Green pulsing	The Smappee EV Base Ultra is charging your EV.	Your EV is being charged.
	Green continuous	The EV is now fully charged.	Disconnect the cable and put it back in its socket of the Smappee EV Base Ultra.
	Red continuous	The Smappee EV Base Ultra is unavailable.	Check the manual or contact your supplier for more info and further steps.
	Red flashing	Your charge card is not authorised.	Contact your charge card supplier.

10. Declaration of conformity

We,

Smappee nv
Evolis 104
B-8530 Harelbeke
Belgium

following the provision of the following EC Directives:

- 2014/35/EU The Low Voltage Directive
- 2014/30/EU The Electromagnetic Compatibility Directive
- 2011/65/EU RoHS Directive

hereby declare that the product:

EVBU-200-CCS3R, EVBU-80-CCS3R

is in conformity with the applicable requirements of the following documents

* Emissions:

(EN61326-1 : 2013)

Radiated Emission: EN 55011:2009 / EN 55032:2015 (Class B)
Conducted Emission: EN 55011:2009 / EN 55032:2015 (Class B)
Harmonic current Emission: EN 61000-3-2:2005 +A1:2008 + A2:2009
Flicker: EN 61000-3-3:2008

* Immunity:

(EN61326-1 : 2013)

ESD : EN 61000-4-2:2008 / EN 61000-4-2 :2009
Radiated immunity : EN 61000-4-3:2006 + A1:2007 + A2: 2010
Power frequency magnetic field: EN 61000-4-8:2009
Voltage dips/interruptions: EN 61000-4-11:2004
Common Mode Immunity: EN 61000-4-6:2008 / EN 61000-4-6:2009
Burst : EN 61000-4-4:2004 / EN 61000-4-4:2012
Surge: EN 61000-4-5:2005 / EN 61000-4-5:2006

* Safety:

Metering Function : IEC 61010-1 Ed 3.0 (2010-06) + A1:2016
DC Charging equipment : IEC 61851-1 (2017), IEC 61851-21-2 (2018), IEC 61851-23 (2014), IEC 61851-24 (2014) , ISO 15118 / EN61558-1

* Other applicable standards and certifications: IEC 60364, IEC 62192-1, IEC 62192-2

Authorized signatory



Stefan Grosjean
CEO