



# BYD Battery-Box Premium Quick Start Guide

LVS 4.0,8.0,12.0,16.0,20.0,24.0

V1.0



BYD Europe B.V.



Be Connect



ENGLISH	.....	3
DEUTSCH	.....	8
ESPAÑOL	.....	14
FRANÇAIS	.....	20
ITALIANO	.....	26
<b>Technical Parameters</b>	.....	31
<b>Instructions</b>	.....	33
<b>Contact</b>	.....	54

## Legal Provisions

All the information in this document is the property of BYD Europe B.V. No part of this document could be reproduced in any way for business use. Internal use is allowed.

BYD Europe B.V. makes no representations or warranties express or implied, with respect to this document or any of the equipment and/or software it may describe, including (with no limitation) any implied warranties of utility, merchantability, or fitness for any particular purpose. All such representations or warranties are expressly disclaimed. Neither BYD Europe B.V. nor its distributors or dealers shall be liable for any indirect, incidental, or consequential damages under any circumstances.

The exclusion of implied warranties may not apply in all cases under some statutes, and thus the above exclusion may not apply.

Specifications are subject to change without notice. Every effort has been made to make this document complete, accurate, and up-to-date. However, BYD Europe B.V. may need to make some improvements under certain circumstances without advance notice. BYD Europe B.V. shall not be responsible for any loss caused by this document, including, but not limited to omissions, errors, typographical errors, arithmetical errors, or listing errors in this document.

All trademarks are recognized.

### Limited Warranty

You can download the current Limited Warranty from the Internet at websites:

BYD Global Service, [www.bydbatterybox.com](http://www.bydbatterybox.com),

BYD service partner in Europe, [www.eft-systems.de](http://www.eft-systems.de),

BYD service partner in Australia, [www.alpspower.com.au](http://www.alpspower.com.au).

### BYD Europe B.V.

's-Gravelandseweg 256, 3125 BK, Schiedam, the Netherlands

## 1. Information on this Document

### 1.1. Validity

This document is valid for the Battery-Box Premium LVS 4.0, 8.0, 12.0, 16.0, 20.0, 24.0.

### 1.2. Target Group

The instructions in this document may only be performed by qualified persons who must have the following skills:

- Knowledge of how batteries work and are operated
- Knowledge of how an inverter works and is operated
- Knowledge of, and adherence to the locally applicable connection requirements, standards, and directives\*

---

\* The local standard for Australia is AS/NZS 5139:2019

- Knowledge of, and adherence to this document and the associated system documentation, including all safety instructions
- Training in dealing with the hazards associated with the installation and operation of electrical equipment and batteries
- Training in the installation and commissioning of electrical equipment

Failure to do so will make any manufacturer's warranty, guarantee or liability null, and void unless you can prove that the damage was not due to non-compliance.

### 1.3. Content and Structure of this Document

This document contains safety information and instructions on installing, connecting, and commissioning. Please finish reading this document before taking any actions on the battery system.

The latest version of this document and the manual for installation, commissioning, and operation are to be found in PDF format at our websites.

This document only contains brief information and may deviate from the real system.

## 2. Safety

### 2.1. Intended Use

The battery system is for residential-and works with a photovoltaic system. It is a 48V Li-ion battery storage system, with the control module on itself. It could be operated in on-grid mode with compatible inverters.

The system should be operated together with Battery-Box Premium LV BMU. The overall system could be connected with the Internet through network cable for diagnosis and firmware updates.

The system must only be used as stationary equipment.

The system is suitable for indoor and outdoor use.

The system must only be operated in connection with a compatible inverter. The list (BYD Battery-Box Premium LVS Minimum Configuration List) of these inverters could be read at our websites.

The system is not suitable for supplying life-sustaining medical devices. Please ensure that no personal injury would lead due to the power outage of the system.

Alterations to the BYD system, e.g., changes or modifications are not allowed unless the written permission of BYD is achieved.

Please download **Be Connect** from Google Play or App Store to accomplish the commissioning of the system.

The enclosed document is an integral part of this system. Keep the documentation in a convenient, dry place for future reference and observe all instructions contained therein.

The type label should always be attached to the system.

### 2.2. IMPORTANT SAFETY INSTRUCTIONS

The system has been designed and tested under international safety requirements. However, to prevent personal injury and property damage and ensure long-term operation of the system, please

do read this section carefully and observe all safety information at all times.

### 2.2.1. Battery Module Leakage

If the battery modules leak electrolytes, contact with the leaking liquid or gas should be avoided. The electrolyte is corrosive, and the contact may cause skin irritation and chemical burns. If one is exposed to the leaked substance, do these actions:

**Inhalation:** Evacuate the contaminated area and seek medical help immediately.

**Eye contact:** Rinse eyes with flowing water for 15 minutes and seek medical help immediately.

**Skin contact:** Wash the affected area thoroughly with soap and water and seek medical help immediately.

**Ingestion:** Induce vomiting and seek medical help immediately.

### 2.2.2. Firefighting Measures

The battery modules may catch fire when it is put into the fire. In case of a fire, please make sure that an ABC or carbon dioxide extinguisher is nearby. Water cannot be used to extinguish the fire.

Full protective clothing and self-contained breathing apparatus are required for the firefighters to extinguish the fire.

### 2.2.3. Battery Modules Handling and Storage Guide

- The battery modules and its components should be protected from damage when transporting and handling.
- The weight of the system may cause injury risk. Please take the weight of the system into account while the system is transported and lifted carefully.
- Do not impact, pull, drag, or step on the battery modules.
- Do not insert unrelated objects into any part of the battery modules.
- Do not throw the battery module into a fire.
- Do not soak the battery modules in water or seawater.
- Do not expose to strong oxidizers.
- Do not short circuit the battery modules.
- The battery modules cannot be stored at high temperatures (more than 60 °C).
- The battery modules cannot be stored directly under the sun.
- The battery modules cannot be stored in a high humidity environment.
- Use the battery modules only as directed.
- Do not use the battery modules if it is defective, or appears cracked, broken or otherwise damaged, or fails to operate.
- Do not attempt to open, disassemble, repair, tamper with, or modify the battery modules. The battery modules are not user-serviceable.
- Do not use cleaning solvents to clean the battery modules.

### 2.2.4. Notice of Property Damage

If the battery system doesn't start at all, please contact BYD authorized service partner within 48 hours. Otherwise, the battery could be permanently damaged.

When the system is installed, it needs to be able to charge and discharge to avoid a deep discharge condition. After the installation, this needs to be checked once a month. If the battery system is not working normally, please get in contact with your local service partner.

During the storage of the battery system, please mind the maximum storage time.

### 2.2.5. Surge Protection





Overvoltages (e. g. in the event of a flash of lightning) can be further conducted into the building and to other connected devices in the same network via the network cables or other data cables if there is no surge protection.

Ensure that the system is integrated into the existing surge protection.









### 2.2.6. Safety Information of the Inverter Manufacturer

Please read and observe all safety information of the inverter manufacturer.

## 3. Symbols on the Battery System

Symbol	Explanation
	Observe the documents Observe all documents supplied with the system.
	Grounding conductor This symbol indicates the position for connecting a grounding conductor.
	WEEE designation Do not dispose of the system together with the household waste but in accordance with the disposal regulations for electronic waste applicable at the installation site.
	CE marking The system complies with the requirements of the applicable EU directives.
	Place it straight up, without inclination or upside down.

---

	Handle with care
	Keep it dry
	Keep the battery modules away from open flame or ignition sources.
	Beware of electrical voltage.
	Beware of a danger zone. This symbol indicates that the system must be additionally grounded if additional grounding or equipotential bonding is required at the installation site.
	Keep the battery modules away from children.
	RCM (Regulatory Compliance Mark), a brief guide to Electrical equipment approvals in Australia
	Do not short circuit.

---

#### 4. EU Declaration of Conformity

The battery system described in this document complies with the applicable European directives. The certificate is available in the download area of our websites.

## Rechtliche Bestimmungen

Alle in diesem Dokument enthaltenen Informationen sind Eigentum von BYD Europe B.V. Dieses Dokument darf weder ganz noch in Teilen für geschäftliche Zwecke reproduziert werden. Die interne Nutzung ist gestattet.

BYD Europe BV gibt keine ausdrücklichen oder stillschweigenden Zusicherungen oder Garantien in Bezug auf dieses Dokument oder die von ihm beschriebenen Geräte und / oder Software ab, einschließlich (ohne Einschränkung) impliziter Garantien für die Nützlichkeit, Handelsfähigkeit oder Eignung für einen bestimmten Zweck. Alle derartigen Zusicherungen oder Gewährleistungen werden ausdrücklich abgelehnt. Weder BYD Europe B.V. noch seine Vertriebshändler oder Händler haften unter irgendwelchen Umständen für indirekte, zufällige oder Folgeschäden.

Der Ausschluss stillschweigender Garantien gilt unter Umständen nicht in allen Fällen, und daher gilt der oben genannte Ausschluss möglicherweise nicht.

Die technischen Daten können jederzeit ohne vorherige Ankündigung geändert werden. Es wurden alle Anstrengungen unternommen, die Informationen in diesem Dokument vollständig, korrekt und aktuell zu halten. Unter bestimmten Umständen kann es jedoch vorkommen, dass BYD Europe B.V. ohne vorherige Ankündigung Verbesserungen vornehmen muss. BYD Europe B.V. ist nicht verantwortlich für Schäden, die durch dieses Dokument verursacht wurden. Dies gilt einschließlich, jedoch nicht beschränkt auf, Auslassungsfehler, Tippfehler, Rechenfehler und Aufzählungsfehler in diesem Dokument.

Alle Warenzeichen werden anerkannt.

### Eingeschränkte Garantie

Sie können die aktuelle beschränkte Garantie aus dem Internet auf folgenden Websites herunterladen:

BYD Global Service, [www.bydbatterybox.com](http://www.bydbatterybox.com),

BYD-Service partner in Europa, [www.eft-systems.de](http://www.eft-systems.de),

BYD-Service partner in Australien, [www.alpspower.com.au](http://www.alpspower.com.au).

### BYD Europe B.V.

's-Gravelandseweg 256, 3125 BK Schiedam, Niederlande

## 1. Informationen zu diesem Dokument

### 1.1. Gültigkeit

Dieses Dokument gilt für die Battery-Box Premium LVS 4.0, 8.0, 12.0, 16.0, 20.0, 24.0.

### 1.2. Zielgruppe

Die Anweisungen in diesem Dokument sind ausschließlich von qualifiziertem Personal auszuführen, das über die folgenden Bedingungen erfüllt:

- Kenntnis über die Funktionsweise und den Betrieb von Batterien
- Kenntnisse über die Funktionsweise und den Betrieb von Wechselrichtern
- Ausbildung zum Einbau und zur Inbetriebnahme von elektrischen Geräten
- Kenntnis und Einhaltung von örtlichen Anschlussvorgaben, Normen und Richtlinie



- Ausbildung zum Umgang mit Gefahren, die beim Einbau und dem Betrieb von elektrischen Geräten und Batterien auftreten können\*
- Kenntnis und Einhaltung der Vorgaben in diesem Dokument und der zugehörigen Systemdokumentation einschließlich aller Sicherheitsvorschriften

Bei Nichtbeachtung erlischt jegliche Herstellergarantie, Garantie oder Haftung, es sei denn, Sie können nachweisen, dass der Schaden nicht auf Nichtbeachtung zurückzuführen ist.

### 1.3. Inhalt und Aufbau dieses Dokuments

Dieses Dokument enthält Sicherheitsinformationen und Anweisungen zur Installation, zum Anschluss und zur Inbetriebnahme. Bitte lesen Sie dieses Dokument vollständig durch, bevor Sie Maßnahmen im System ergreifen.

Die neueste Version dieses Dokuments und das Handbuch für Installation, Inbetriebnahme und Betrieb finden Sie im PDF-Format auf unseren Websites

Dieses Dokument enthält nur kurze Informationen und kann vom tatsächlichen System abweichen.

## 2. Sicherheit

### 2.1. Bestimmungsgemäße Verwendung

Dieses System ist für die Verwendung zuhause sowie durch Kleinbetriebe ausgelegt und arbeitet mit einer Fotovoltaikanlage. Es handelt sich um ein Energiespeichersystem mit 48-V-Lithium-Ionen-Batterie und eigenem Steuermodul.

Das System sollte zusammen mit der Battery-Box Premium LV BMU betrieben werden. Das Gesamtsystem könnte zur Diagnose und Firmware-Aktualisierung über ein Netzwerkkabel mit dem Internet verbunden sein.

Das System darf ausschließlich stationär verwendet werden.

Das System ist für den Innen- und Außenbereich geeignet.

Das System darf nur in Verbindung mit einem kompatiblen Wechselrichter betrieben werden. Die Liste (BYD Battery-Box Premium LVS Minimum Configuration List) dieser Wechselrichter kann auf unseren Websites gelesen werden.

Das System ist nicht zur Stromversorgung von lebenserhaltenden medizinischen Geräten geeignet. Es ist sicherzustellen, dass es bei Ausfall der Stromversorgung durch dieses Gerät nicht zu Verletzungen kommen kann.

Änderungen am BYD-System, z. B. Änderungen oder Modifikationen, sind nur zulässig, wenn die schriftliche Genehmigung von BYD vorliegt.

Laden Sie Be Connect von Google Play oder dem App Store herunter, um die Inbetriebnahme des Systems durchzuführen.

Das mitgelieferte Dokument ist ein wesentlicher Bestandteil dieses Systems. Die Dokumentation ist an einem gut zugänglichen, trockenen Ort griffbereit aufzubewahren und alle darin enthaltenen Anweisungen sind zu beachten.

Das Typenschild sollte immer am System angebracht sein

---

\*Der lokale Standard für Australien ist AS / NZS 5139: 2019.

## 2.2. WICHTIGE SICHERHEITSVORSCHRIFTEN

Das System wurde unter internationalen Sicherheitsanforderungen entwickelt und getestet. Lesen Sie diesen Abschnitt jedoch sorgfältig durch und beachten Sie stets alle Sicherheitsinformationen, um Personen- und Sachschäden zu vermeiden und einen langfristigen Betrieb des Systems zu gewährleisten.

### 2.2.1. Undichtigkeit des Batteriemoduls

Wenn aus den Batteriemodulen Elektrolyt austritt, sollte der Kontakt mit der austretenden Flüssigkeit oder dem austretenden Gas vermieden werden. Der Elektrolyt ist ätzend und der Kontakt kann Hautreizungen und Verätzungen verursachen. Wenn jemand der ausgetretenen Substanz ausgesetzt ist, gehen Sie folgendermaßen vor:

**Einatmen:** Evakuieren Sie den kontaminierten Bereich und suchen Sie sofort einen Arzt auf.

**Augenkontakt:** Spülen Sie die Augen 15 Minuten lang mit fließendem Wasser aus und suchen Sie sofort einen Arzt auf.

**Hautkontakt:** Den betroffenen Bereich umgehend gründlich mit Seife und Wasser waschen und anschließend einen Arzt aufsuchen.

**Verschlucken:** Erbrechen herbeiführen und sofort einen Arzt aufsuchen.

### 2.2.2. Brandbekämpfungsmaßnahmen

Die Batteriemodule können sich beim Brand entzünden. Stellen Sie im Brandfall sicher, dass sich ein ABC- oder Kohlendioxidlöscher in der Nähe befindet. Wasser kann nicht zum Löschen des Feuers verwendet werden.

Die Feuerwehr muss zum Löschen des Brandes mit voller Schutzbekleidung sowie umgebungsluftunabhängigem Atemschutzgerät ausgerüstet sein.

### 2.2.3. Anleitung zur Handhabung und Lagerung der Batteriemodule

- Die Batteriemodule und deren Bauteile müssen bei Transport und sonstiger Handhabung vor Schäden geschützt werden.
- Das Gewicht des Systems kann zu Verletzungen führen. Bitte berücksichtigen Sie das Gewicht des Systems, während das System vorsichtig transportiert und angehoben wird.
- Die Batteriemodule dürfen keinen Stößen ausgesetzt werden. Außerdem ist ein Ziehen, Umherschleifen und Steigen auf die Batteriemodule untersagt.
- Keine Fremdkörper jeglicher Art in die Batteriemodule einführen.
- Die Batteriemodule stets von Feuer fernhalten.
- Die Batteriemodule nicht in Wasser oder Meerwasser tauchen.
- Keinen starken Oxidatoren aussetzen.
- Die Batteriemodules nicht kurzschließen.
- Die Batteriemodule können nicht bei hohen Temperaturen (über 60 ° C) gelagert werden.
- Die Batterien dürfen bei der Lagerung keiner direkten Sonneneinstrahlung ausgesetzt sein.
- Die Batteriemodules dürfen nicht in feuchter Umgebung gelagert werden.
- Die Batteriemodules ausschließlich im Rahmen der Vorgaben verwenden.

- Die Batteriemodule nicht verwenden, wenn diese defekt sind, Risse, Bruchstellen oder sonstige Beschädigungen aufweisen oder nicht ordnungsgemäß funktionieren.
- Versuchen Sie nicht, die Batteriemodule zu öffnen, zu zerlegen, zu reparieren, zu manipulieren oder zu modifizieren. Die Batteriemodule können nicht vom Benutzer gewartet werden.
- Keine Reinigungslösungen zum Reinigen der Batteriemodule verwenden.

#### Warnung vor elektrischem Schlag

Es besteht Lebensgefahr durch Stromschlag, wenn stromführende Komponenten oder Gleichstromkabel berührt werden.

Die an das System angeschlossenen Gleichstromkabel können unter Spannung stehen. Das Berühren spannungsführender DC-Kabel führt zum Tod oder zu schweren Verletzungen durch Stromschlag.

- Vor Arbeiten das Produkt und die Batterie spannungsfrei schalten und gegen Wiedereinschalten sichern.
- Keine freiliegenden spannungsführenden Teile oder Kabel berühren.
- Die Klemmleiste mit angeschlossenen DC-Leitern nicht unter Last aus dem Steckplatz herausziehen.
- Tragen Sie bei allen Arbeiten an der Anlage eine geeignete persönliche Schutzausrüstung.

#### **2.2.4. Hinweis auf Sachschaden**

Wenn das System überhaupt nicht startet, wenden Sie sich innerhalb von 48 Stunden an den BYD-Kundendienst. Andernfalls kann der Akku dauerhaft beschädigt werden.

#### **2.2.5. Überspannungsschutz Notice of property damage**

Wenn das Batteriesystem überhaupt nicht startet, wenden Sie sich innerhalb von 48 Stunden an einen von BYD autorisierten Servicepartner. Andernfalls könnte der Akku dauerhaft beschädigt werden.











Wenn das System installiert ist, muss es in der Lage sein, zu laden und zu entladen, um einen Tiefentladungszustand zu vermeiden. Nach der Installation muss dies einmal im Monat überprüft werden. Wenn das Batteriesystem nicht normal funktioniert, wenden Sie sich bitte an Ihren örtlichen Servicepartner.

Beachten Sie bei der Lagerung des Batteriesystems die maximale Lagerzeit.

#### **2.2.6. Sicherheitshinweise des Wechselrichterherstellers**

Alle Sicherheitshinweise des Wechselrichterherstellers müssen gelesen und beachtet werden.

### 3. Symbole auf dem System

Symbol	Erläuterung
	Die Dokumente beachten Alle mit dem System mitgelieferten Dokumente beachten.
	Erdleiter Dieses Symbol kennzeichnet die Position zum Anschließen eines Erdleiters.
	WEEE-Kennzeichnung Das System darf nicht im Haushaltsmüll entsorgt werden. Die Entsorgung muss entsprechend den am Aufstellungsort geltenden Vorschriften für das Entsorgen von Elektronik-Altgeräten erfolgen.
	CE-Kennzeichnung Dieses System entspricht den Anforderungen der geltenden EU-Richtlinien.
	Das System muss gerade, senkrecht und richtig herum aufgestellt werden.
	Vorsichtig behandeln
	Trocken halten
	Die Batteriemodule von offenen Flammen sowie Zündquellen fernhalten.
	Warnung vor elektrischer Spannung
	Warnung vor Gefahrenzone Dieses Symbol weist darauf hin, dass das System zusätzlich geerdet werden muss, wenn am Aufstellungsort eine zusätzliche Erdung bzw. ein Potentialausgleich erforderlich ist.
	Die Batteriemodule von Kindern fernhalten.



RCM (Regulatory Compliance Mark), eine kurze Anleitung zu Zulassungen für elektrische Geräte in Australien

---



Nicht kurzschließen.

---

#### 4. EU-Konformitätserklärung

Das in diesem Dokument beschriebene Batteriesystem entspricht den geltenden europäischen Richtlinien. Das Zertifikat ist im Downloadbereich unserer Websites verfügbar.

## Disposiciones legales

Toda la información contenida en el presente documento es propiedad de BYD Europe B.V. Queda prohibida la reproducción de cualquier parte de este documento con fines comerciales. Está permitido el uso interno.

BYD Europe BV no hace representaciones o garantías expresas o implícitas, con respecto a este documento o cualquier equipo y / o software que pueda describir, incluyendo (sin limitación) cualquier garantía implícita de utilidad, comerciabilidad o adecuación para un propósito particular. . Todas estas representaciones o garantías están expresamente excluidas. Ni BYD Europe B.V. ni sus distribuidores o concesionarios serán responsables de ningún daño indirecto, incidental o consecuente bajo ninguna circunstancia.

La exclusión de garantías implícitas puede no aplicarse en todos los casos bajo algunos estatutos y, por lo tanto, la exclusión anterior puede no aplicarse.

Las especificaciones están sujetas a cambios sin previo aviso. Se ha hecho todo lo posible para que este documento sea completo, preciso y actualizado. No obstante, BYD Europe B.V. puede tener que realizar mejoras en circunstancias determinadas sin previo aviso. BYD Europe B.V. declina toda responsabilidad por posibles pérdidas causadas por el contenido de este documento, incluyendo pero no limitado a errores por omisión, errores tipográficos, errores aritméticos o errores de listados en este documento.

Todas las marcas registradas están reconocidas.

### Garantía limitada

Puede descargar la Garantía limitada actual de Internet en los sitios web

Servicio global de BYD, <https://www.bydbatterybox.com>,

BYD socio de servicio en Europa, <https://www.eft-systems.de>,

BYD socio de servicio en Australia, <https://www.alpspower.com.au>.

### BYD Europe B.V.

's-Gravelandseweg 256, 3125 BK, Schiedam, Países Bajos

## 1. Información sobre este documento

### 1.1. Validez

Este documento es válido para la caja de batería Premium LVS 4.0, 8.0, 12.0, 16.0, 20.0, 24.0.

### 1.2. Grupo destinatario

Las instrucciones contenidas en el presente documento van dirigidas a personal cualificado con las habilidades siguientes:

- Conocimiento sobre el funcionamiento y la operación de baterías
- Conocimiento sobre el funcionamiento y la operación de inversores
- Formación en la actuación en caso de emergencia relacionada con la instalación y la operación de equipo eléctrico y baterías
- Formación en la instalación y la puesta en servicio de equipo eléctrico

- Conocimiento y cumplimiento de lo mencionado en el presente documento y en la documentación relacionada con el sistema, incluyendo todas las instrucciones de seguridad
- Conocimiento y cumplimiento de los requisitos, las normativas y las directivas de conexión aplicables a nivel local\*

De lo contrario, la garantía, la garantía o la responsabilidad del fabricante serán nulas e inválidas, a menos que pueda probar que el daño no se debió al incumplimiento.

### 1.3. Contenido y estructura del presente documento

El presente documento contiene información de seguridad e instrucciones para la instalación, conexión y puesta en servicio. Lea este documento hasta el final antes de realizar cualquier operación en el sistema.

La versión más reciente de este documento y el manual de instalación, puesta en marcha y operación se encuentran en formato PDF en nuestros sitios web.

Este documento solo contiene información breve y puede diferir del sistema real.

## 2. Seguridad

### 2.1. Uso previsto

Este sistema se ha previsto para uso doméstico y en pequeñas empresas, y funciona mediante un sistema fotovoltaico. Es un sistema de almacenamiento por batería de iones de litio de 48 V que contiene un módulo de control propio. Puede operarse de modo autónomo (aislado o fuera de red) o conectado a la red con inversores compatibles.

El sistema debe funcionar junto con la BMU Battery-Box Premium LV. El sistema general podría conectarse a Internet a través de un cable de red para el diagnóstico y las actualizaciones de firmware.

The system is suitable for indoor and outdoor use.

El sistema solo debe funcionar en conexión con un inversor compatible. La lista (BYD Battery-Box Premium LVS Minimum Configuration List) de estos inversores se puede leer en nuestros sitios web.

Este sistema no es apto para alimentar equipos médicos de soporte de vida. Asegúrese de que el corte del suministro eléctrico del sistema no pueda causar lesiones.

Queda prohibido realizar cualquier alteración del sistema BYD, p. ej. cambios o modificaciones, sin obtener la autorización previa por escrito de BYD.

Descargue *Be Connect* desde Google Play o App Store para realizar la puesta en marcha del sistema.

El documento adjunto forma parte integral de este sistema. Guarde la documentación en un lugar adecuado y seco para futuras consultas y cumpla las instrucciones contenidas en la misma.

La etiqueta de tipo siempre debe adjuntarse al sistema.

---

\*El estándar local para Australia es AS / NZS 5139: 2019.

## 2.2. INSTRUCCIONES IMPORTANTES DE SEGURIDAD

El sistema ha sido diseñado y probado bajo los requisitos internacionales de seguridad. Sin embargo, para evitar lesiones personales y daños a la propiedad y garantizar el funcionamiento a largo plazo del sistema, lea detenidamente esta sección y observe toda la información de seguridad en todo momento.

### 2.2.1. Fugas en el módulo de la batería

Si los módulos de batería tienen fugas de electrolito, se debe evitar el contacto con el líquido o gas con fugas. El electrolito es corrosivo y el contacto puede causar irritación de la piel y quemaduras químicas. Si uno está expuesto a la sustancia filtrada, realice estas acciones:

**Inhalación:** Evacue el área contaminada y busque ayuda médica de inmediato.

**Contacto con los ojos:** Enjuague los ojos con agua corriente durante 15 minutos y busque ayuda médica de inmediato.

**Contacto con la piel:** Lave bien el área afectada con agua y jabón, y busque ayuda médica de inmediato.

**Ingestión:** Induzca el vómito y busque ayuda médica de inmediato.

### 2.2.2. Medidas contra incendios

Los módulos de batería pueden incendiarse cuando se incendia. En caso de incendio, asegúrese de tener cerca un extintor de ABC o dióxido de carbono. El agua no puede usarse para extinguir el fuego.

El personal antiincendios debe llevar ropa de protección completa y aparatos respiratorios autónomos para extinguir el incendio.

### 2.2.3. Guía de manejo y almacenamiento de los módulos de la batería

- Proteja los módulos de la batería y sus componentes contra posibles daños durante el transporte y manejo.
- El peso del sistema puede causar riesgo de lesiones. Tenga en cuenta el peso del sistema mientras se transporta y se levanta con cuidado.
- No someta los módulos de la batería a impactos ni tire, arrastre ni pise los mismos.
- No introduzca objetos ajenos al sistema en ninguna parte de los módulos de la batería.
- No arroje el módulo de la batería al fuego.
- No empape los módulos de la batería con agua ni agua salada.
- No los exponga a oxidantes fuertes.
- No cortocircuite los módulos de la batería.
- No almacene los módulos de la batería a temperaturas elevadas (superiores a 60°C).
- No almacene los módulos de la batería en lugares expuestos a la luz directa del sol.
- No almacene los módulos de la batería en entornos con mucha humedad.
- Use los módulos de la batería solo como se indica en las instrucciones.



- No use los módulos de la batería si están defectuosos o agrietados, rotos o dañados, o si no funcionan.
- No intente abrir, desmontar, reparar, manipular o modificar los módulos de batería. Los módulos de batería no son reparables por el usuario.
- No limpie los módulos de la batería con disolventes de limpieza.

### 2.2.4. Aviso de daños a la propiedad

Si el sistema de batería no se inicia en absoluto, comuníquese con un socio de servicio autorizado de BYD dentro de las 48 horas. De lo contrario, la batería podría dañarse permanentemente.

Cuando se instala el sistema, debe poder cargarse y descargarse para evitar una condición de descarga profunda. Después de la instalación, esto debe verificarse una vez al mes. Si el sistema de batería no funciona normalmente, póngase en contacto con su socio de servicio local.

Durante el almacenamiento del sistema de batería, tenga en cuenta el tiempo máximo de almacenamiento.

### 2.2.5. Protección contra sobretensión

Si no se dispone de una protección contra sobretensión, dicha sobretensión (p. ej. en caso de impacto de un relámpago) puede transmitirse por el edificio hacia otros dispositivos conectados en.





la misma red a través de los cables de la red y otros cables de datos. En ese caso, tocar piezas y cables bajo tensión causará lesiones graves o la muerte por descarga eléctrica.

Asegúrese de que el sistema esté integrado en la protección existente contra sobretensión.

### 2.2.6. Información de seguridad del fabricante del inversor

Lea y cumpla toda la información de seguridad del fabricante del inversor.

## 3. Símbolos en el sistema

Símbolo	Significado
	<p>Consulte los documentos</p> <p>Consulte todos los documentos suministrados con el sistema.</p>
	<p>Conductor de puesta a tierra</p> <p>Este símbolo indica la posición de conexión de un conductor de puesta a tierra.</p>
	<p>Designación RAEE</p> <p>No deseché el sistema en los residuos domésticos, sino que debe cumplirse la normativa correspondiente a la recogida de aparatos eléctricos y electrónicos en el lugar de instalación.</p>
	<p>Marcado CE</p> <p>El sistema cumple los requisitos de las directivas aplicables de la UE.</p>
	<p>Colóquelo en posición vertical, sin inclinarlo ni ponerlo boca abajo.</p>



Manejar con cuidado



Mantener seco



Mantenga los módulos de la batería alejados de llamas y fuentes de ignición.



Cuidado, tensión eléctrica.



Cuidado, zona de peligro

Este símbolo indica que este sistema debe ponerse a tierra por separado si se requiere una puesta a tierra adicional o conexión equipotencial en el lugar de instalación.



Mantenga los módulos de la batería fuera del alcance de los niños.



RCM (Marca de cumplimiento normativo), una breve guía para las aprobaciones de equipos eléctricos en Australia



No cortocircuitar.

#### **4. Declaración de conformidad UE**

El sistema de batería descrito en este documento cumple con las directivas europeas aplicables. El certificado está disponible en el área de descarga de nuestros sitios web.

## Dispositions légales

Toutes les informations contenues dans ce document sont la propriété de BYD Europe B.V. Aucune partie de ce document ne peut être reproduite de quelque manière que ce soit à des fins commerciales. L'utilisation interne est autorisée.

BYD Europe BV ne fait aucune représentation ou garantie expresse ou implicite, en ce qui concerne ce document ou tout équipement et / ou logiciel qu'il peut décrire, y compris (sans limitation) toute garantie implicite d'utilité, de qualité marchande ou d'adéquation à un usage particulier. Toutes ces déclarations ou garanties sont expressément exclues. Ni BYD Europe B.V. ni ses distributeurs ou revendeurs ne seront en aucun cas responsables des dommages indirects, accessoires ou consécutifs.

L'exclusion des garanties implicites peut ne pas s'appliquer dans tous les cas en vertu de certaines lois, et donc l'exclusion ci-dessus peut ne pas s'appliquer.

Les spécifications sont sujettes à changement sans préavis. Tous les efforts ont été déployés pour que ce document soit complet, précis et à jour. Toutefois, BYD Europe B.V. devra peut-être apporter des améliorations dans certaines circonstances sans préavis. BYD Europe B.V. ne saurait être tenu responsable des dommages causés par le présent document, y compris, notamment, les erreurs d'omission, les erreurs typographiques, les erreurs arithmétiques ou les erreurs de référencement dans ce document.

Toutes les marques déposées sont reconnues.

### Garantie limitée

Vous pouvez télécharger la garantie limitée actuelle sur Internet sur les sites Web:

Service mondial BYD, [www.bydbatterybox.com](http://www.bydbatterybox.com)

Partenaire de service BYD en Europe, [www.eft-systems.de](http://www.eft-systems.de)

Partenaire de service BYD en Australie, [www.alpspower.com.au](http://www.alpspower.com.au).

### BYD Europe B.V.

's-Gravelandseweg 256, 3125 BK Schiedam, Pays-Bas

## 1. Information sur ce document

### 1.1. Validité

Ce document est valable pour le boîtier de batterie Premium LVS 4.0, 8.0, 12.0, 16.0, 20.0, 24.0.

### 1.2. Groupe ciblé

Les instructions de ce document ne peuvent être exécutées que par des personnes qualifiées possédant les compétences suivantes:

- Connaissance du fonctionnement et de l'exploitation des batteries
- Connaissance du fonctionnement et de l'exploitation d'un onduleur
- Formation à la gestion des risques liés à l'installation et au fonctionnement des équipements électriques et des batteries
- Formation à l'installation et à la mise en service des équipements électriques

- Connaissance et respect de ce document et de la documentation système associée, y compris de toutes les instructions de sécurité.
- Connaissance et respect des exigences, normes et directives de connexion applicables localement\*

Si vous ne le faites pas, la garantie, la garantie ou la responsabilité du fabricant sera nulle et non avenue, sauf si vous pouvez prouver que les dommages n'étaient pas dus à la non-conformité.

### 1.3. Contenu et structure de ce document

Ce document contient des informations de sécurité et des instructions pour l'installation, la connexion et la mise en service. Veuillez terminer la lecture de ce document avant d'effectuer toutes actions sur le système.

La dernière version de ce document et le manuel d'installation, de mise en service et de fonctionnement sont disponibles au format PDF sur nos sites Web.

Ce document ne contient que de brèves informations et peut s'écarter du système réel.

## 2. Sécurité

### 2.1. Utilisation prévue

Le système est destiné aux particuliers et aux petites entreprises et fonctionne avec un système photovoltaïque. C'est un système de stockage de batterie Li-ion 48V, avec module de commande intégré. Il peut être exploité en mode hors réseau ou en réseau avec des onduleurs compatibles.

Le système doit être utilisé avec Battery-Box Premium LV BMU. Le système global peut être connecté à Internet via un câble réseau pour le diagnostic et les mises à jour du firmware.

Le système ne doit être utilisé que comme équipement fixe.

Le système convient à une utilisation intérieure et extérieure

Le système ne doit être utilisé qu'avec un onduleur compatible. La liste (BYD Battery-Box Premium LVS Minimum Configuration List) de ces onduleurs peut être consultée sur nos sites Web.

Le système n'est pas adapté à l'alimentation des dispositifs médicaux de maintien en vie. Veuillez-vous assurer qu'aucun dommage corporel ne serait causé par une panne de courant du système.

Des modifications apportées au système BYD, comme des transformations, ne sont pas autorisées, sauf autorisation écrite de BYD.

Veuillez télécharger Be Connect depuis Google Play ou App Store pour effectuer la mise en service du système.

Le document ci-joint fait partie intégrante de ce système. Conservez la documentation dans un endroit sec et pratique pour toute référence ultérieure et observez toutes les instructions qui y figurent.

La plaque signalétique doit toujours être attachée au système.

---

\*La norme locale pour l'Australie est AS / NZS 5139: 2019

## 2.2. CONSIGNES DE SECURITE IMPORTANTES

Le système a été conçu et testé conformément aux exigences internationales de sécurité. Cependant, pour éviter les blessures corporelles et les dommages matériels et assurer un fonctionnement à long terme du système, veuillez lire attentivement cette section et observer à tout moment toutes les informations de sécurité.

### 2.2.1. Fuite de module de batterie

Si les modules de batterie fuient de l'électrolyte, le contact avec le liquide ou le gaz qui fuit doit être évité. L'électrolyte est corrosif et le contact peut provoquer une irritation cutanée et des brûlures chimiques. Si quelqu'un est exposé à la substance qui a fui, procédez comme suit:

**Inhalation:** Evacuez la zone contaminée et recherchez immédiatement de l'aide médicale.

**Contact avec les yeux:** Rincez les yeux à l'eau courante pendant 15 minutes et recherchez immédiatement de l'aide médicale.

**Contact avec la peau:** Lavez soigneusement la zone touchée avec de l'eau et du savon et recherchez immédiatement de l'aide médicale.

**Ingestion:** Provoquez le vomissement et recherchez immédiatement de l'aide médicale.

### 2.2.2. Lutte contre l'incendie

Les modules de batterie peuvent prendre feu lorsqu'ils sont mis à feu. En cas d'incendie, veuillez vous assurer qu'un extincteur ABC ou au dioxyde de carbone se trouve à proximité. L'eau ne peut pas être utilisée pour éteindre le feu.

Des vêtements de protection complets et un appareil respiratoire autonome sont nécessaires pour que les pompiers puissent éteindre l'incendie.

### 2.2.3. Guide de manipulation et de stockage des modules de batterie

- Les modules de batterie et composants doivent être protégés des dommages pendant le transport et la manipulation.
- Le poids du système peut entraîner des risques de blessures. Veuillez prendre en compte le poids du système pendant le transport et le levage du système.
- Ne frappez, ni ne tirez ou ne montez sur les modules de batterie.
- N'insérez pas d'objets sans rapport dans les composants des modules de batterie.
- Ne jetez pas les modules de batterie dans un feu.
- N'immergez pas les modules de batterie dans l'eau ou l'eau de mer.
- Ne l'exposez pas à des oxydants puissants.
- Ne court-circuitez pas les modules de batterie.
- Les modules de batterie ne peuvent pas être stockés à des températures élevées (plus de 60 °C).
- Les modules de batterie ne doivent pas être stockés directement au soleil.
- Les modules de batterie ne doivent pas être stockés dans un endroit humide.
- Utilisez les modules de batterie uniquement comme indiqué.

- N'utilisez pas les modules de batterie s'ils sont défectueux, s'ils paraissent fissurés, brisés ou autrement endommagés, ou s'ils ne fonctionnent pas correctement.
- N'essayez pas d'ouvrir, de démonter, de réparer, d'altérer ou de modifier les modules de batterie. Les modules de batterie ne sont pas réparables par l'utilisateur.
- N'utilisez pas de solvants de nettoyage pour nettoyer les modules de batterie.

#### Avertissement de choc électrique

Danger de mort dû à un choc électrique lorsque des composants sous tension ou des câbles CC sont touchés.

Les câbles CC connectés au système sont peut-être sous tension. Le contact avec des câbles CC sous tension entraîne la mort ou des blessures graves dues à un choc électrique.

- Débranchez la batterie de la source de tension et assurez-vous qu'elle ne peut pas être reconnectée avant d'intervenir sur l'appareil.
- Ne touchez pas les pièces ou les câbles non isolés.
- Ne retirez pas le bornier avec les conducteurs CC connectés de l'emplacement sous charge.
- Portez un équipement de protection individuelle approprié pour tous les travaux sur le système.

#### 2.2.4. Avis de dommages matériels

Si le système ne démarre pas du tout, veuillez contacter le service autorisé BYD dans les 48 heures. Sinon, la batterie pourrait être endommagée de façon permanente. Aviso de daños a la propiedad.

Lorsque le système est installé, il doit pouvoir se charger et se décharger pour éviter une condition de décharge profonde. Après l'installation, cela doit être vérifié une fois par mois. Si le système de batterie ne fonctionne pas normalement, veuillez contacter votre partenaire de service local.

Pendant le stockage du système de batterie, veuillez tenir compte de la durée de stockage maximale.

#### 2.2.5. Protection contre les surtensions

Les surtensions (par exemple, foudre) peuvent également être transmises au bâtiment et à d'autres appareils connectés du même réseau via les câbles réseau ou d'autres câbles de données en l'absence de protection contre les surtensions. Le fait de toucher des pièces et des câbles sous tension peut entraîner la mort ou des blessures mortelles par électrocution.

Assurez-vous que le système est intégré à la protection contre les surtensions existante.

#### 2.2.6. Informations de sécurité du fabricant de l'onduleur

Veuillez lire et observer toutes les informations de sécurité du fabricant de l'onduleur.

### 3. Symboles sur le système

Symbole	Explications
	<p>Observez les documents</p> <p>Observez tous les documents fournis avec le système.</p>



Conducteur de mise à la terre

Ce symbole indique la position pour connecter un conducteur de mise à la terre.



Appellation DEEE

Ne jetez pas le système avec les déchets ménagers, mais conformément aux consignes d'élimination des déchets électroniques en vigueur sur le site d'installation.



Marquage CE

Le système est conforme aux directives UE en vigueur.



Placez-le à l'endroit, tête vers le haut, sans inclinaison ni tourner à l'envers.



Manipuler avec soin



Garder le sec



Tenez les modules de batterie à l'écart des flammes nues ou des sources d'inflammation.



Attention au tension électrique.



Attention au zone de danger

Ce symbole indique que le système doit également être mis à la terre si une mise à la terre ou une liaison équipotentielle supplémentaire est requise sur le site d'installation.



Gardez les modules de batterie hors de portée des enfants.



RCM (Regulatory Compliance Mark), un bref guide pour les approbations d'équipements électriques en Australie



Ne court-circuitez pas.



#### **4. Déclaration de conformité de l'UE**

Le système de batterie décrit dans ce document est conforme aux directives européennes applicables. Le certificat est disponible dans la zone de téléchargement de nos sites Web.

## Disposizioni giuridiche

Tutte le informazioni presenti in questo documento sono proprietà di BYD Europe B.V. È vietata qualsiasi riproduzione del documento o di sue parti per scopi commerciali. È permesso l'uso interno.

BYD Europe BV non rilascia dichiarazioni o garanzie espresse o implicite, rispetto a questo documento o alle attrezzature e / o software che può descrivere, incluso (senza limitazione) qualsiasi garanzia implicita di utilità, commerciabilità o idoneità per scopi particolari. Tutte tali dichiarazioni o garanzie sono espressamente negate. Né BYD Europe B.V. né i suoi distributori o rivenditori saranno responsabili per eventuali danni indiretti, incidentali o consequenziali in qualsiasi circostanza.

L'exclusion des garanties implicites peut ne pas s'appliquer dans tous les cas en vertu de certaines lois, et donc l'exclusion ci-dessus peut ne pas s'appliquer.

I dati tecnici sono soggetti a modifiche, senza previo avviso. Si è cercato di rendere questo documento completo, preciso e aggiornato. Tuttavia, BYD Europe B.V. si riserva il diritto di apportare migliorie, in determinate circostanze, senza previo avviso. BYD Europe B.V. non è responsabile per danni causati da questo documento, compresi senza limitazioni errori di omissione, errori tipografici, errori aritmetici o errori di elencazione presenti in tale documento.

Tutti i marchi sono riconosciuti.

### Garanzia limitata

È possibile scaricare l'attuale lettera di garanzia limitata da Internet sui siti Web:

BYD Global Service, [www.bydbatterybox.com](http://www.bydbatterybox.com),

Partner di servizio BYD in Europa, [www.eft-systems.de](http://www.eft-systems.de),

Partner di servizio BYD in Australia, [www.alpspower.com.au](http://www.alpspower.com.au).

### BYD Europe B.V.

's-Gravelandseweg 256, 3125 BK, Schiedam, Paesi Bassi

## 1. Informazioni relative a questo documento

### 1.1. Validità

Questo documento è valido per la scatola di batterie Battery-Box Premium LVS 4.0, 8.0, 12.0, 16.0, 20.0, 24.0.

### 1.2. Gruppo target

Le istruzioni in questo documento devono essere eseguite solo da persone qualificate e in possesso delle seguenti competenze:

- Conoscenza dell'uso e del funzionamento delle batterie
- Conoscenza dell'uso e del funzionamento di un invertitore
- Formazione su come affrontare i pericoli relativi all'installazione e al funzionamento di attrezzature elettriche e batterie
- Formazione sull'installazione e sulla messa in servizio delle attrezzature elettriche

- Conoscenza e osservanza di questo documento e della relativa documentazione del sistema, compreso tutte le istruzioni sulla sicurezza
- Conoscenza e osservanza dei requisiti locali per il collegamento, degli standard e delle direttive\*

Si vous ne le faites pas, la garantie, la garantie ou la responsabilité du fabricant sera nulle et non avenue, sauf si vous pouvez prouver que les dommages n'étaient pas dus à la non-conformité.

### 1.3. Contenuto e struttura di questo documento

Questo documento contiene informazioni relative alla sicurezza e istruzioni per l'installazione, il collegamento e la messa in servizio. Leggere completamente questo documento prima di eseguire qualsiasi intervento sul sistema.

L'ultima versione di questo documento e il manuale di installazione, messa in servizio e funzionamento sono disponibili in formato PDF sui nostri siti Web.

Questo documento contiene solo brevi informazioni e può discostarsi dal sistema reale.

## 2. Sicurezza

### 2.1. Uso previsto

Il sistema è previsto per un uso residenziale e per piccole imprese commerciali e funziona con un sistema fotovoltaico. C'est un système de stockage de batterie Li-ion 48V, avec module de commande intégré. Il peut être exploité en mode hors réseau ou en réseau avec des onduleurs compatibles.

Il sistema deve funzionare insieme alla Battery-Box Premium LV BMU. L'intero sistema potrebbe essere collegato a Internet tramite cavo di rete per diagnosi e aggiornamenti del firmware.

Il sistema deve essere utilizzato solo come apparecchiatura fissa.

Il sistema è adatto per uso interno ed esterno.

Il sistema deve essere utilizzato solo in collegamento con un inverter compatibile. L'elenco (BYD Battery-Box Premium LVS Minimum Configuration List) di questi inverter può essere letto sui nostri siti Web.

Il sistema non è adatto per alimentare dispositivi medici salvavita. Garantire che un black-out del sistema non provochi lesioni personali.

È vietata qualsiasi manomissione al sistema BYD, ad es. modifiche o sostituzioni, a meno che non ci sia un'autorizzazione scritta da parte di BYD.

Scaricare *Be Connect* da Google Play o App Store per eseguire la messa in servizio del sistema.

Il documento allegato è parte integrante di questo sistema. Conservare la documentazione in un luogo adatto e asciutto per eventuali futuri riferimenti, e osservare tutte le istruzioni contenute al suo interno.

L'etichetta del tipo deve essere sempre attaccata al Sistema.

### 2.2. IMPORTANTI ISTRUZIONI SULLA SICUREZZA

Il sistema è stato progettato e testato in base ai requisiti di sicurezza internazionali. Tuttavia, per prevenire lesioni personali e danni materiali e garantire il funzionamento a lungo termine del sistema, leggere attentamente questa sezione e osservare tutte le informazioni di sicurezza in ogni momento.

---

\* Lo standard locale per l'Australia è AS / NZS 5139: 2019.

### 2.2.1. Perdita del modulo di batteria

Se i moduli batteria perdono elettrolita, evitare il contatto con il liquido o il gas che perde. L'elettrolita è corrosivo e il contatto può causare irritazione alla pelle e ustioni chimiche. Se si è esposti alla sostanza fuoriuscita, fare queste azioni:

**Inalazione:** Evacuare l'area contaminata e consultare immediatamente un medico.

**Contatto con gli occhi:** Sciacquare gli occhi con acqua corrente per 15 minuti e consultare immediatamente un medico.

**Contatto con la pelle:** Lavare bene l'area in questione con acqua e sapone e consultare immediatamente un medico.

**Ingestione:** Indurre il vomito e consultare immediatamente un medico.

### 2.2.2. Misure antincendio

I moduli batteria potrebbero incendiarsi quando viene messo a fuoco. In caso di incendio, assicurarsi che un estintore ABC o di anidride carbonica si trovi nelle vicinanze. L'acqua non può essere utilizzata per estinguere l'incendio.

Le persone impegnate nell'estinzione dell'incendio devono indossare il completo equipaggiamento di protezione personale e l'autorespiratore.

### 2.2.3. Guida all'uso e alla conservazione dei moduli di batteria

- Durante il loro trasporto e l'uso, i moduli di batteria e i suoi componenti devono essere protetti contro i danni.
- Il peso del sistema può causare rischi di lesioni. Tenere conto del peso del sistema mentre il sistema viene trasportato e sollevato con cura.
- Non colpire, tirare, trascinare o calpestare i moduli di batteria.
- Non inserire corpi estranei in nessuna parte dei moduli di batteria.
- Non bruciare il modulo di batteria.
- Non immergere i moduli di batteria in acqua o nell'acqua di mare.
- Non esporli a ossidanti forti.
- Non sottoporre i moduli di batteria a cortocircuito.
- I moduli batteria non possono essere conservati ad alte temperature (più di 60 °C).
- I moduli di batteria non devono essere conservati direttamente sotto il sole.
- I moduli di batteria non devono essere conservati in ambienti molto umidi.
- Utilizzare i moduli di batteria esclusivamente nel modo indicato.
- Non utilizzare i moduli di batteria se sono difettosi o se evidenziano rotture, incrinature o altri danni, oppure se non funzionano correttamente.
- Non tentare di aprire, smontare, riparare, manomettere o modificare i moduli batteria. I moduli batteria non sono riparabili dall'utente.
- Non utilizzare solventi di pulizia per pulire i moduli di batteria.

### 2.2.4. Avis de dommages matériels

Se il sistema della batteria non si avvia affatto, contattare il centro di assistenza autorizzato BYD entro 48 ore. Altrimenti, la batteria potrebbe essere danneggiata in modo permanente.

Quando il sistema è installato, deve essere in grado di caricare e scaricare per evitare una condizione di scarica profonda. Dopo l'installazione, è necessario verificarlo una volta al mese. Se il sistema batteria non funziona normalmente, contattare il proprio partner di assistenza locale.

Durante la conservazione del sistema batteria, tenere presente il tempo massimo di conservazione.

### 2.2.5. Protezione da sovratensione







In assenza di una protezione da sovratensione, eventuali sovratensioni (ad es. in caso di fulmini) possono arrivare all'interno dell'edificio e su altri dispositivi collegati nella stessa rete tramite i cavi di rete o altri cavi di dati. Il contatto con i cavi e le parti sotto tensione può causare lesioni molto gravi, anche mortali, a causa della scossa elettrica.

Accertarsi che il sistema sia integrato nella protezione da sovratensione esistente.







### 2.2.6. Informazioni sulla sicurezza del produttore dell'invertitore

Leggere e osservare tutte le informazioni sulla sicurezza del produttore dell'invertitore.

## 3. Simboli sul sistema

Simbolo	Spiegazione
	Attenersi alla documentazione Attenersi alla documentazione fornita con il sistema.
	Conduttore di messa a terra Questo simbolo indica la posizione per il collegamento di un conduttore di messa a terra.
	Specifica WEEE Non smaltire il sistema assieme ai rifiuti domestici, bensì in conformità alle disposizioni sullo smaltimento dei rifiuti elettronici vigenti sul luogo di installazione.
	Contrassegno CE Il sistema soddisfa i requisiti delle direttive UE relative.
	Posizionare il sistema in verticale, senza inclinarlo o rovesciarlo.
	Maneggiarlo con cura
	Tenerlo asciutto

---







	Tenere i moduli di batteria lontani da fiamme libere o da fonti infiammabili.
	Attenzione alla tensione elettrica.
	Attenzione all'area di pericolo Questo simbolo indica che si deve eseguire una messa a terra aggiuntiva del sistema se questa o un collegamento equipotenziale sono richiesti sul luogo di installazione.
	Tenere i moduli di batteria fuori dalla portata dei bambini.
	RCM (Marchio di conformità alle normative), una breve guida alle approvazioni di apparecchiature elettriche in Australia
	Non sottoporlo a cortocircuito.

---

#### 4. Dichiarazione di conformità UE

Il sistema di batterie descritto in questo documento è conforme alle direttive europee applicabili. Il certificato è disponibile nell'area download dei nostri siti Web

## Technical Parameters

						
	LVS 4.0	LVS 8.0	LVS 12.0	LVS 16.0	LVS 20.0	LVS 24.0
Battery Module	LVS (4 kWh, 51.2 V, 45 kg)					
Number of Modules	1	2	3	4	5	6
Usable Energy [1]	4 kWh	8 kWh	12 kWh	16 kWh	20 kWh	24 kWh
Max Cont. Output Current [2]	65 A	130 A	195 A	250 A	250 A	250 A
Peak Output Current [2]	90 A, 5 s	180 A, 5 s	270 A, 5 s	360 A, 5 s	360 A, 5 s	360 A, 5 s
Dimensions (H/W/D)	478 x 650 x 298 mm	711 x 650 x 298 mm	944 x 650 x 298 mm	1177 x 650 x 298 mm	1410 x 650 x 298 mm	1643 x 650 x 298 mm
Weight	64 kg	109 kg	154 kg	199 kg	244 kg	289 kg
Nominal Voltage	51.2 V					
Operating Voltage	40-57.6 V					
Operating Temperature	-10 °C to +50°C					
Battery Cell Technology	Lithium Iron Phosphate (cobalt-free)					
Communication	CAN / RS485					
Enclosure Protection Rating	IP55					
Round-Trip Efficiency	≥95%					
Scalability [3]	Max. 64 Modules in Parallel (256 kWh)				Single Tower Only	
Certification	VDE2510-50 / IEC62619 / CE / CEC / UN38.3					
Applications	ON Grid / ON Grid + Backup / OFF Grid					
Warranty [4]	10 Years					
Compatible Inverters	Refer to BYD Battery-Box Premium LVS Minimum Configuration List					
Battery Designation	IFpP/47/174/120/16S/M/-10+50/90					

[1] DC Usable Energy, Test conditions: 100% DOD, 0.2C charge & discharge at + 25 °C. System Usable Energy may vary with different inverter brands

[2] Charge derating will occur between -10 °C and +5 °C











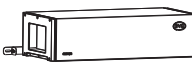
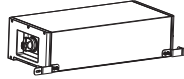
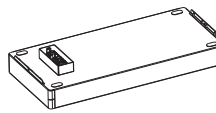

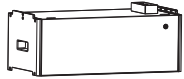



[3] Parallel tower function only available for 1 to 4 battery modules per tower. LVS 20.0 and LVS 24.0 can only be used as a single tower.

[4] Conditions apply. Refer to BYD Battery-Box Premium Limited Warranty Letter.







# Instructions



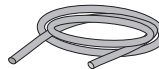

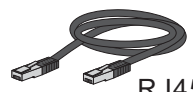

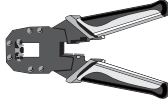

1. **en** Scope of delivery **de** Lieferumfang **es** Alcance de suministro  
**fr** Contenu de la livraison **it** Fornitura

X1  <b>A1</b> PDU		X1  <b>A2</b> PDU(For Australia Market)		X1  <b>B</b> Base		X2  <b>C</b> Communication Gland		X1  <b>J</b> Battery Module	
X2  <b>D</b> Hanger (PDU Part)	X2  <b>E</b> Hanger (Wall Part)	X4  <b>F</b> M5 Screw	X4  <b>G</b> Foot	X2  <b>H</b> M6 Bolt and Nut	X1  <b>I</b> Documents	X3  <b>K</b> M4 Screw	X3  <b>K</b> M4 Screw		
X2  <b>L</b> DC Connector	X2  <b>M</b> Metal Terminal	X2  <b>N</b> Rubber Core	X2  <b>O</b> O-Ring	X2  <b>P</b> Claw	X2  <b>Q</b> Cap				

2. **en** Not included in Scope of Delivery **de** Nicht im Lieferumfang enthalten  
**es** No incluido en el volumen de entrega **fr** Non inclus dans la livraison  
**it** Non compreso nella fornitura

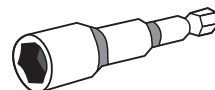
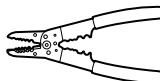
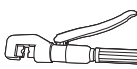
x2  <b>R</b> DC Cable(35mm <sup>2</sup> /50mm <sup>2</sup> /70mm <sup>2</sup> )	x2  <b>S</b> Expansion Anchor Bolt(M8x40)	 <b>T</b> Cat5 Shield	x1  <b>U</b> PE with Terminal(SC16-5)
---	---	---	---

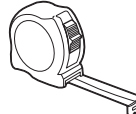















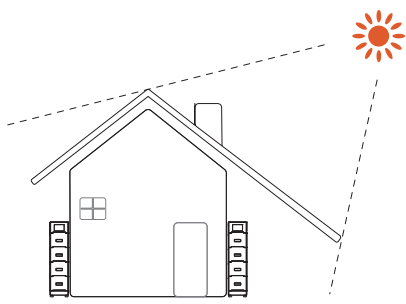

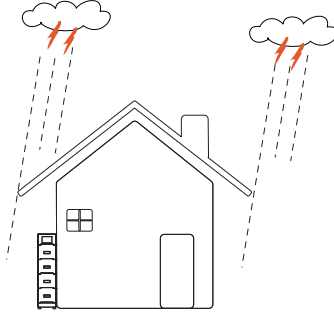
3. **en** Tools **de** Werkzeuge **es** Herramientas **fr** Outils **it** Utensili

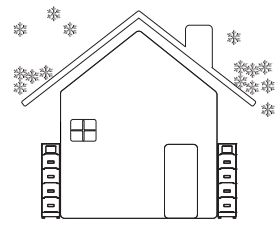
 Network Wire Clamp	 Pen	 Phillips Screwdriver Bit	 Torque Wrench	 Cylinder Screwdriver
 Wire Stripper	 Crimping Plier	 Wrench	 Tape Measure	 Drill

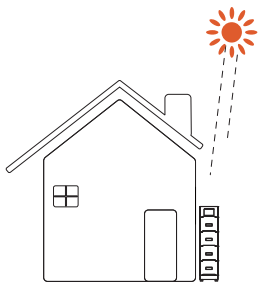

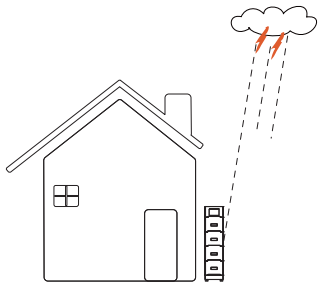

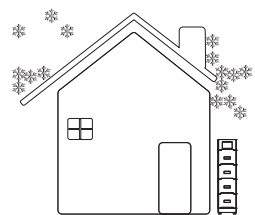
4. **en** Installation Location **de** Aufstellungsort **es** Lugar de instalación  
**fr** Emplacement d'installation **it** Luogo di installazione

 Max +50° C	 Min -10° C	 RH. +5% ~ +95%	 	 
 	 	 		
 	 	 		



5. **en** Module Parallel Connection Limitation  
**de** Einschränkung der Parallelschaltung des Moduls  
**es** Limitación de conexión en paralelo del módulo  
**fr** Limitation de connexion parallèle du module  
**it** Limitazione della connessione parallela del modulo

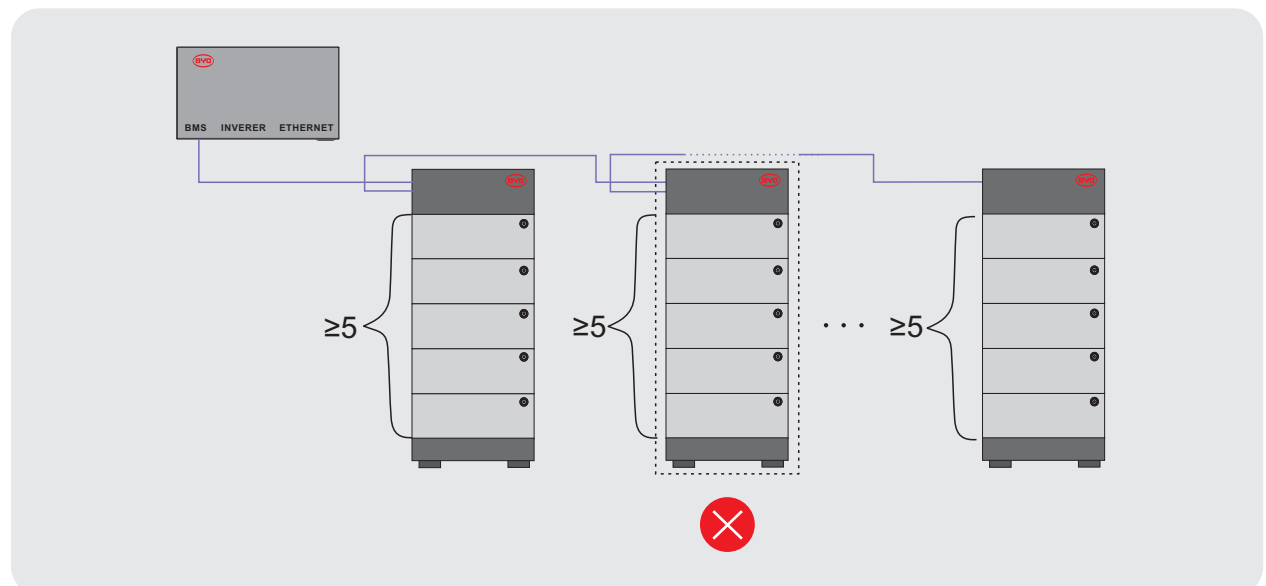
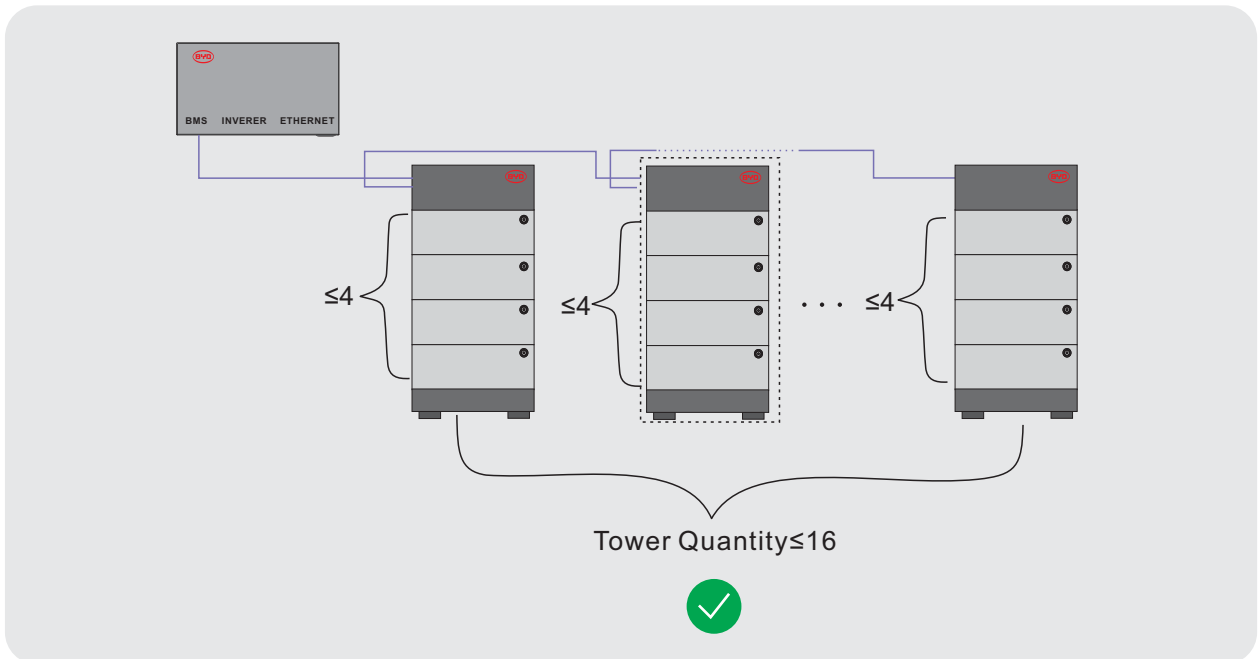
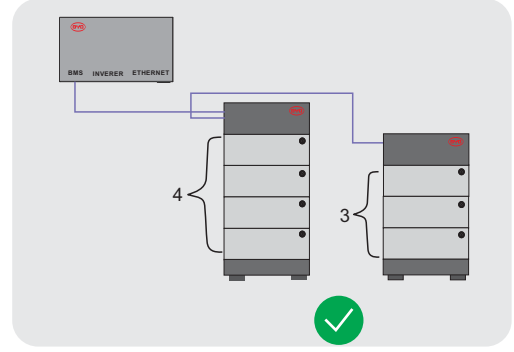
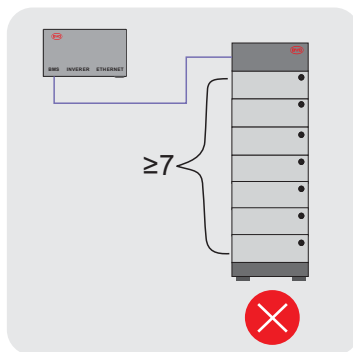
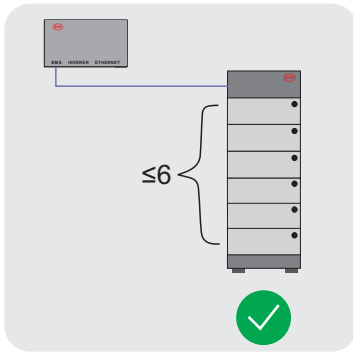



6. **en** Installation **de** Aufstellung **es** Instalación **fr** Installation **it** Installazione

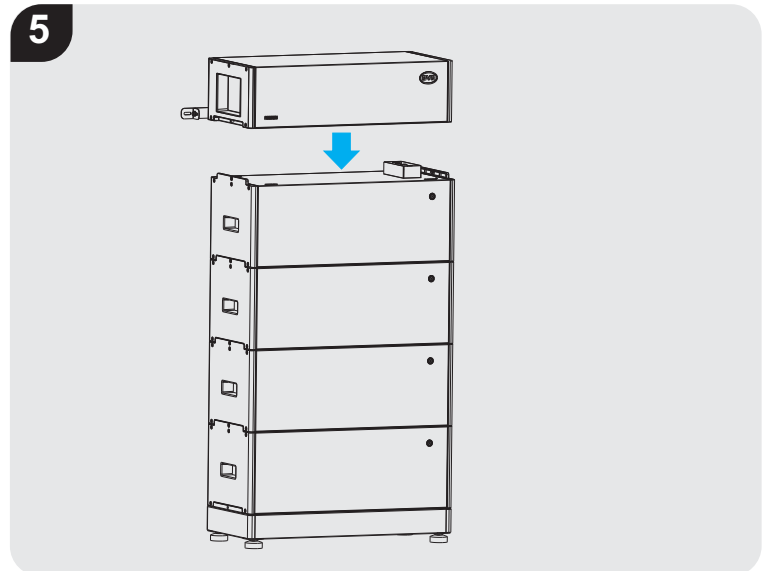
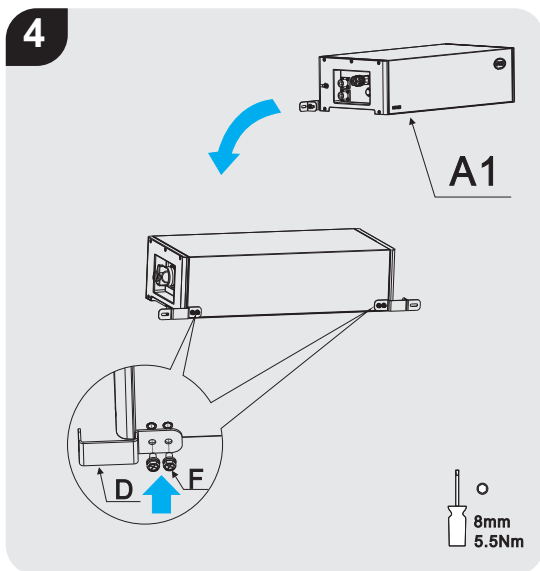
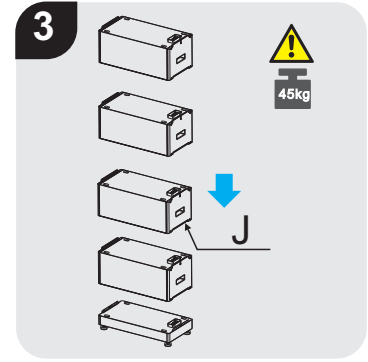
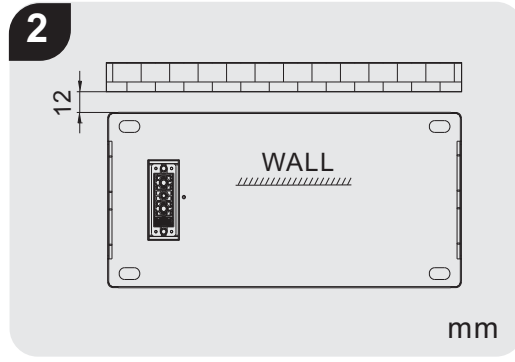
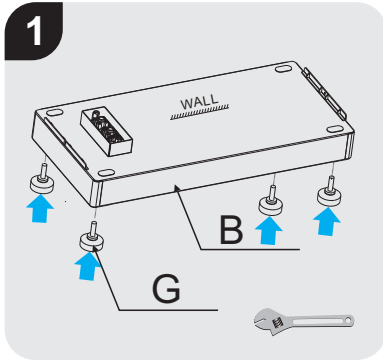

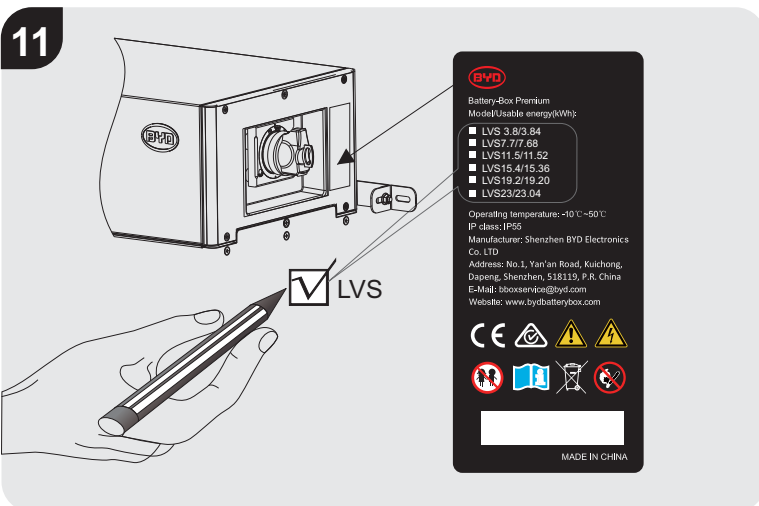
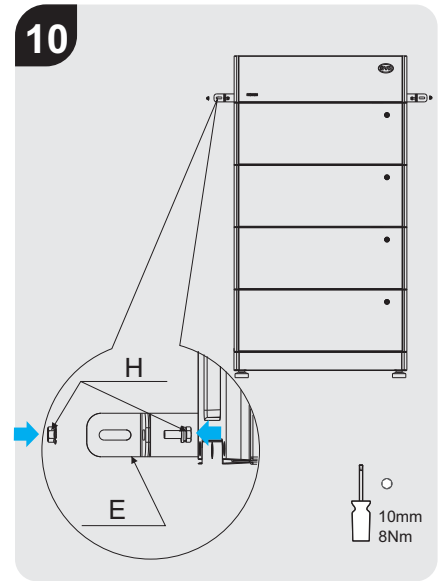
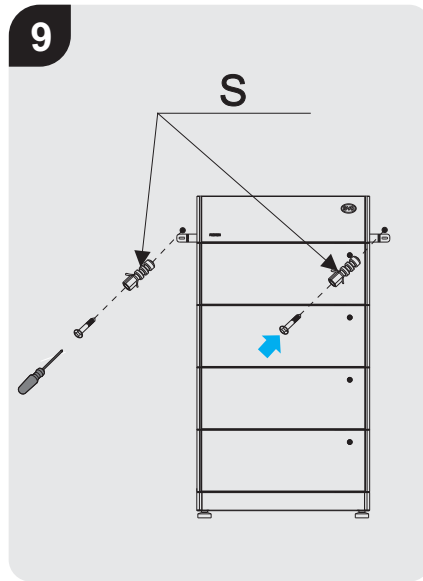
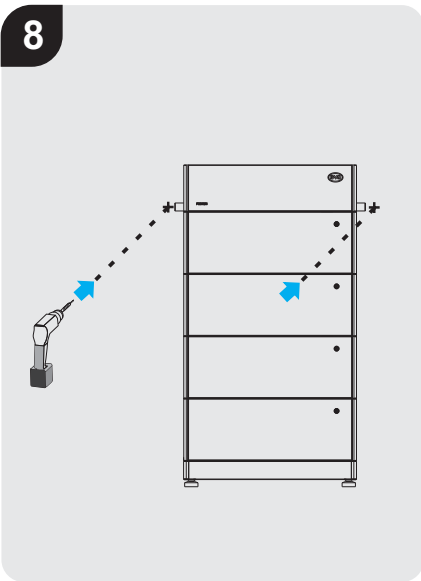
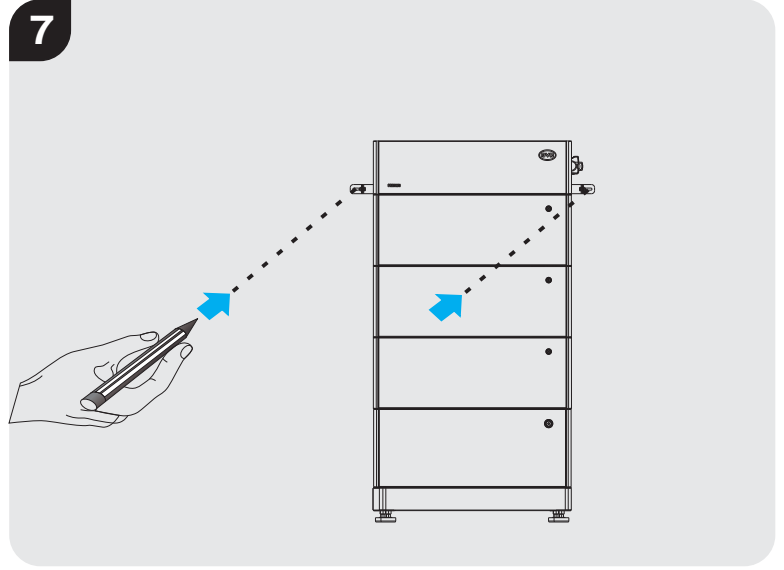
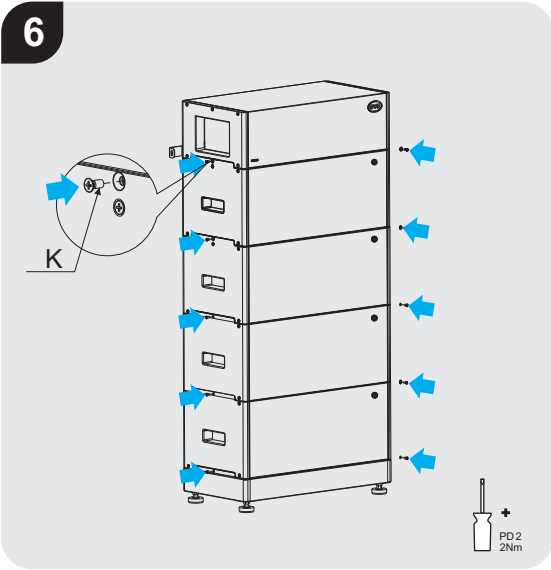



7. **en** Connection Diagram **de** Anschlussplan **es** Plan de conexión  
**fr** Diagramme de connexion **it** Schema dei collegamenti

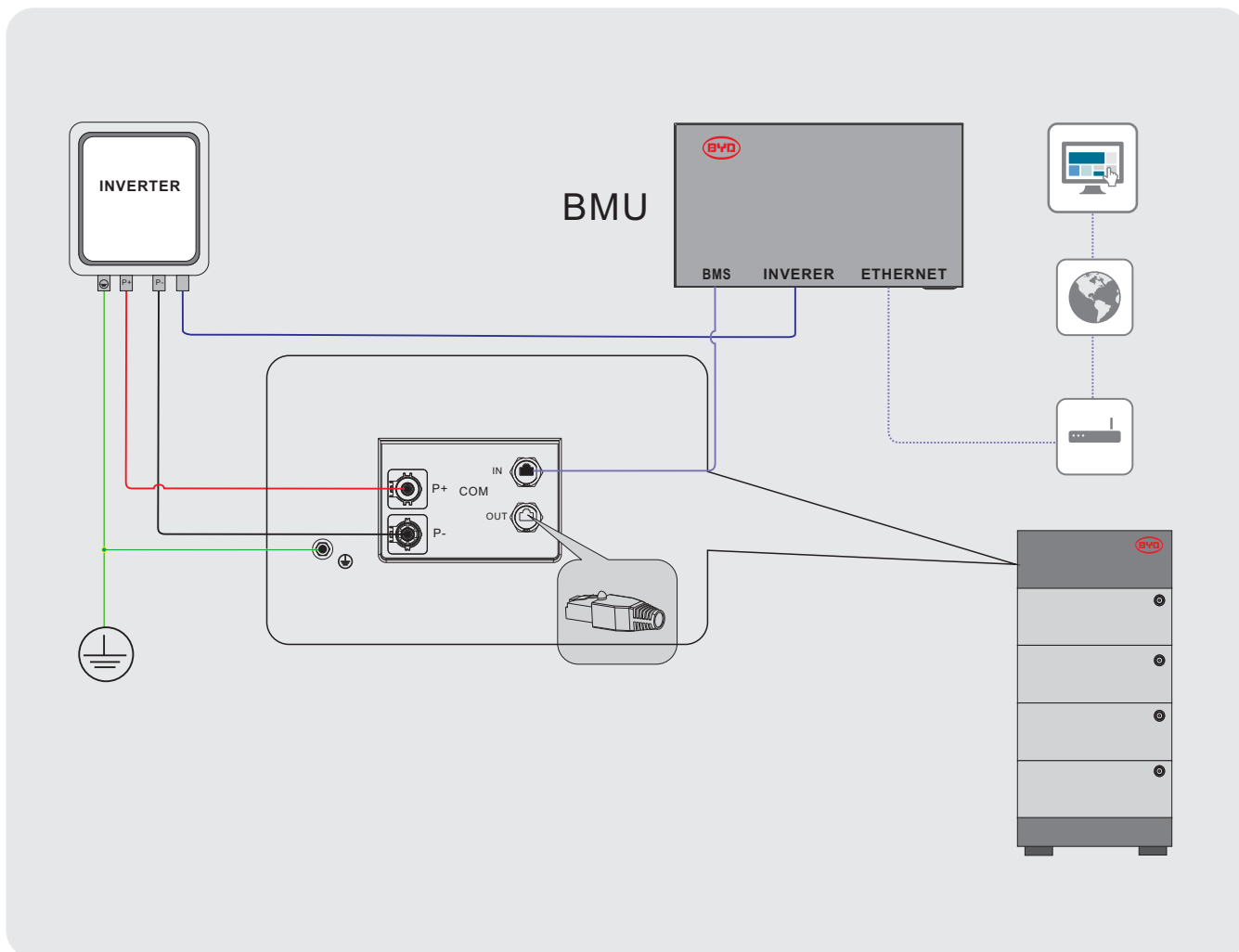



# 1 To 8

## BMU Inverter Port Assignment



	BMU	SMA	STUDER	VICTRON	SELECTRONIC	SOLAREEDGE	GOODWE
CAN H	4	4	4	7	1	4	4
CAN L	5	5	5	8	2	5	5

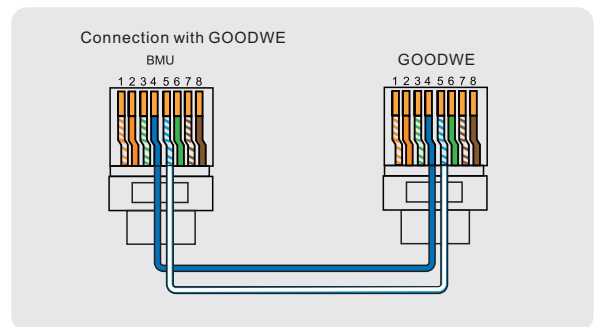
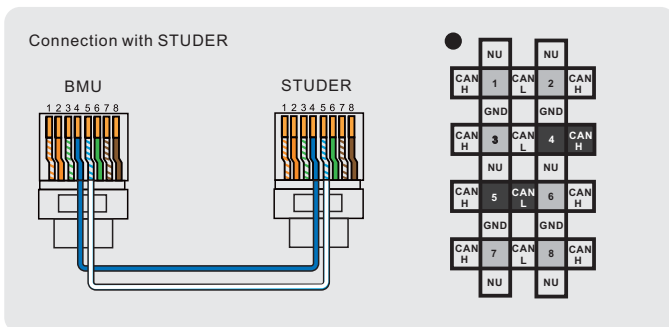
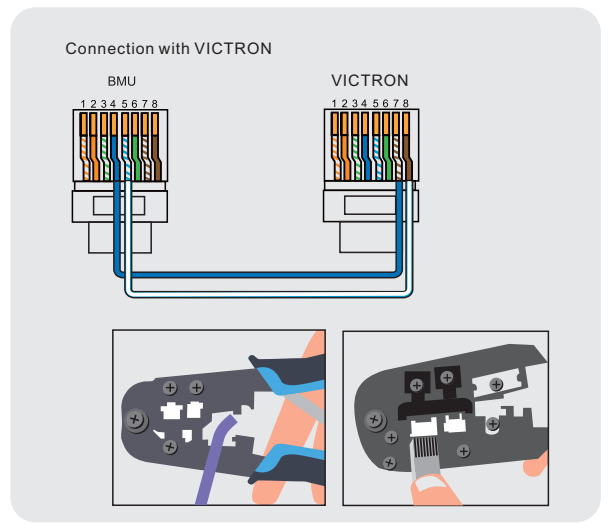
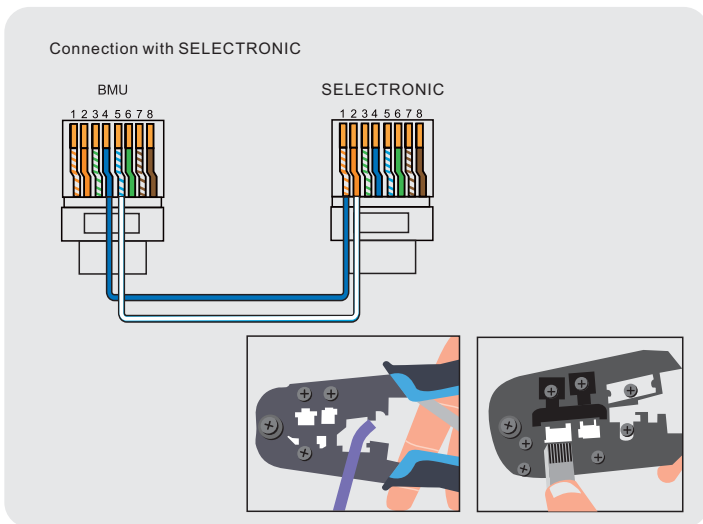
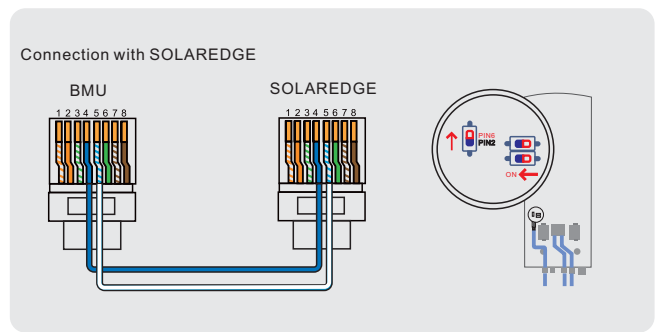
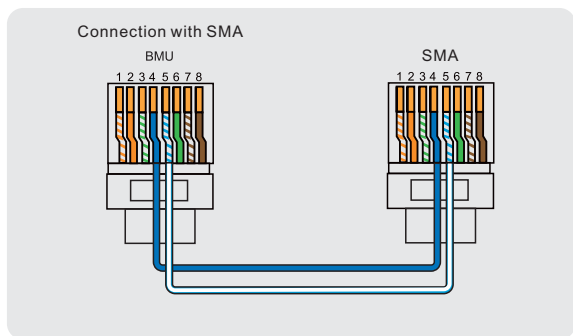

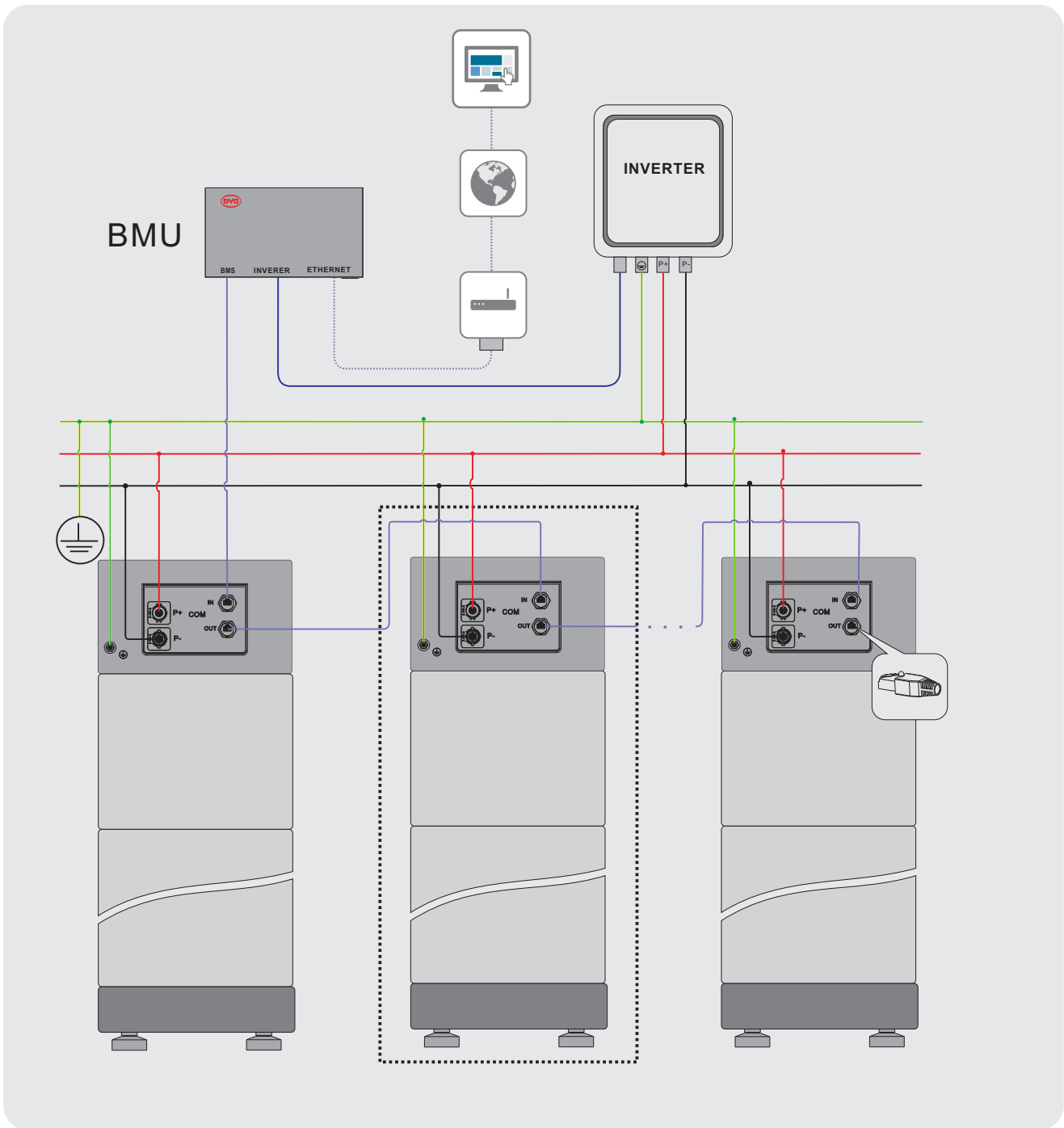



8. **en** Connecting the Grounding Conductor **de** Anschließen des Erdungsleiters  
**es** Conexión del conductor de tierra **fr** Connexion du conducteur de mise à la terre  
**it** Collegamento del conduttore di terra

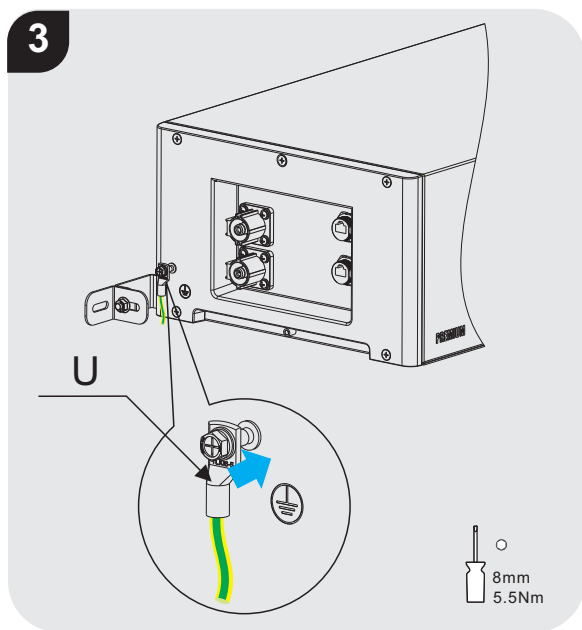
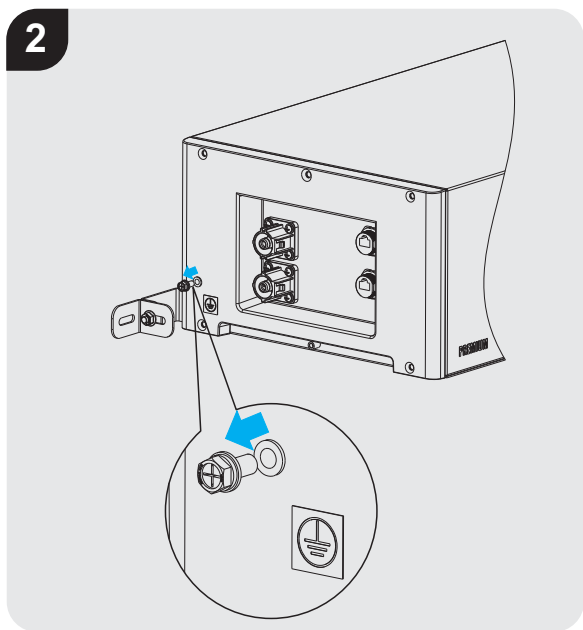
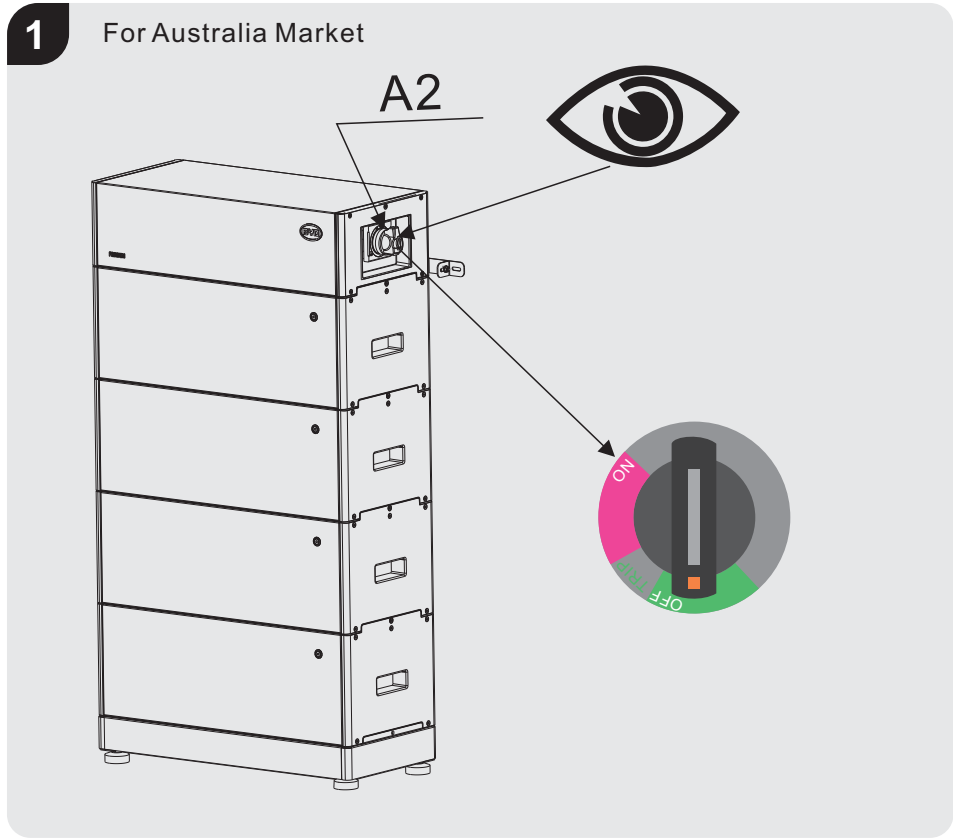





9. **en** Connecting the Data Cable  
**de** Anschließen des Datenkabels  
**es** Conexión del cable de datos para  
**fr** Connexion du câble de données pour  
**it** Collegamento del cavo dati per

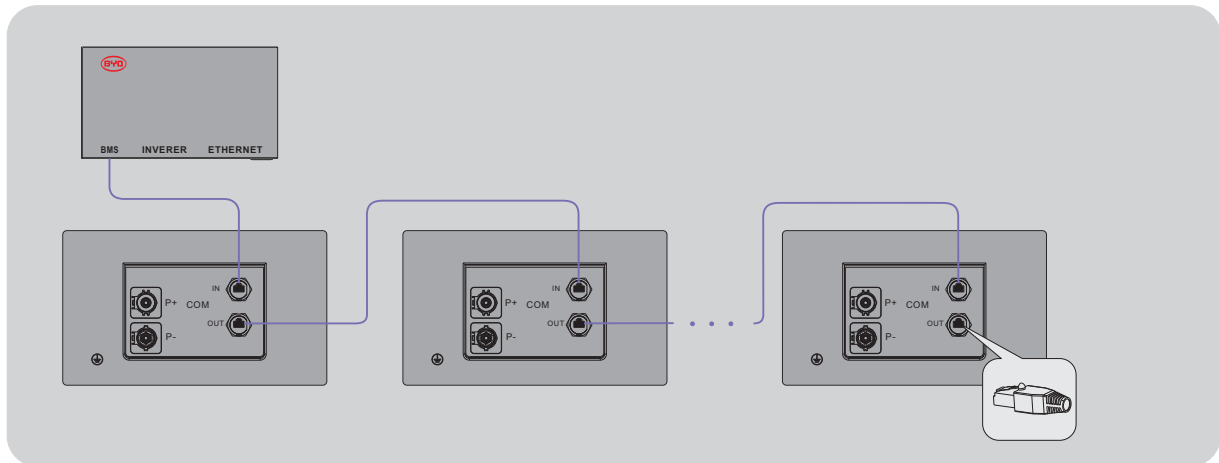
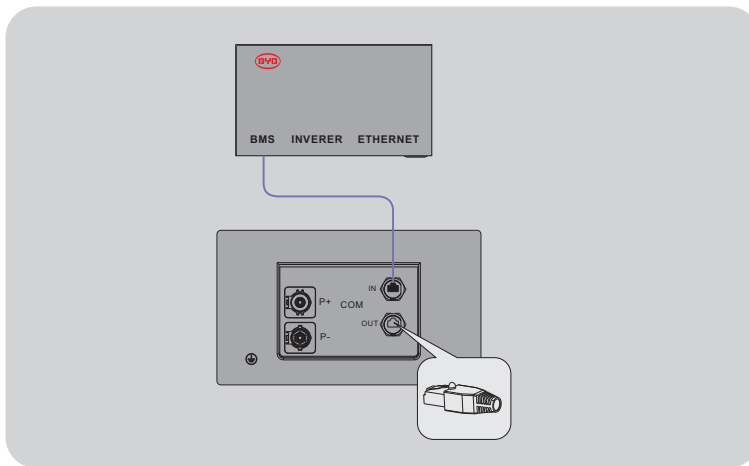



9.1 **en** To Connect Data Cable **de** Datenkabel anschließen  
**es** Para conectar el cable de datos  
**fr** Pour connecter le cable de données  
**it** Per collegare il cavo dati

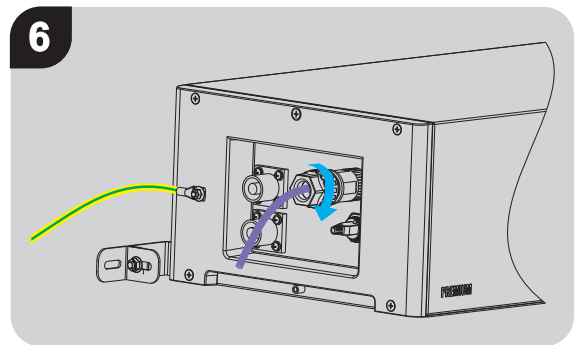
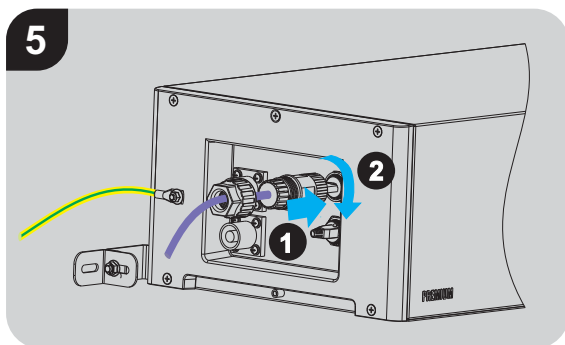
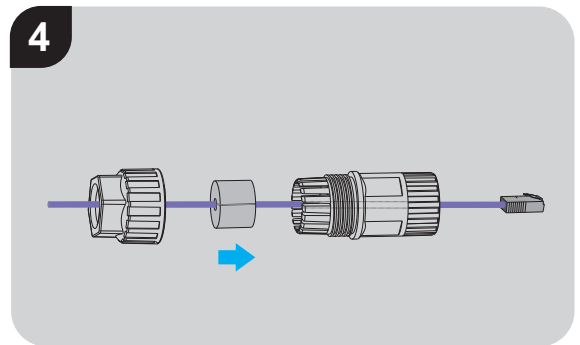
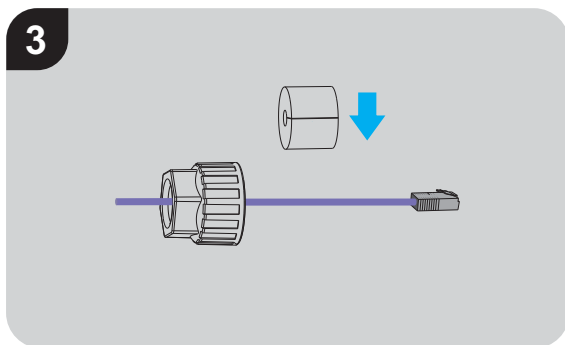
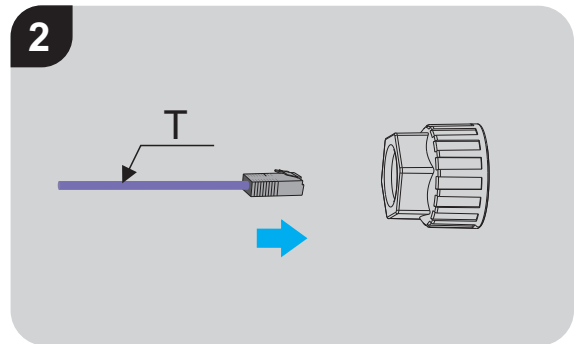
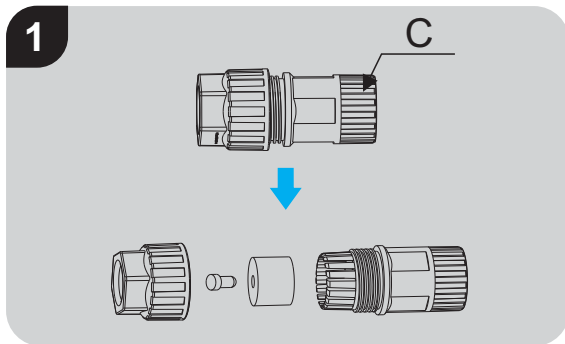



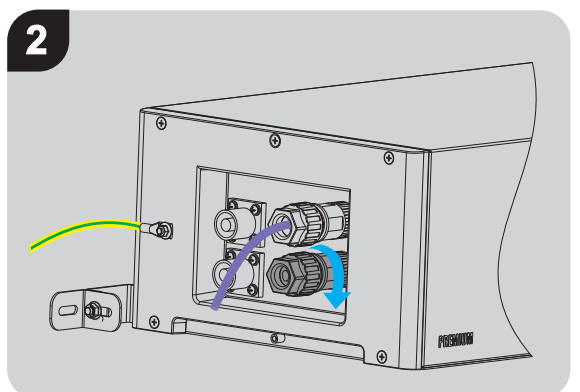
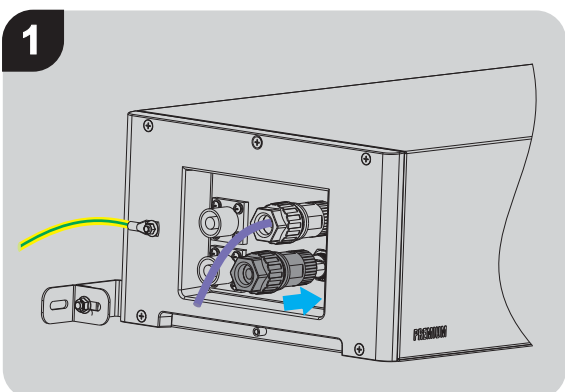





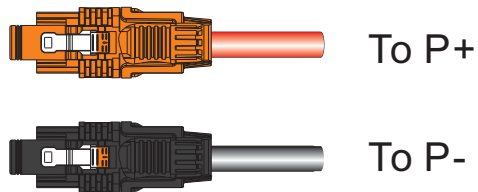





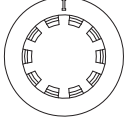
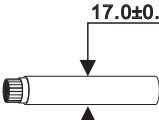

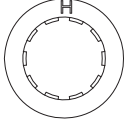
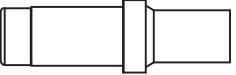
9.2 **en** To Cover the Terminal Resistor **de** Um den Anschlusswiderstand abzudecken  
**es** Para cubrir la resistencia terminal **fr** Pour couvrir la résistance terminale  
**it** Per coprire la resistenza terminale

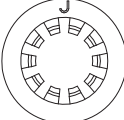
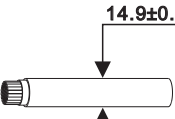

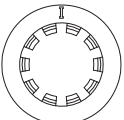

10. **en** Connecting the DC Power Cable  
**de** DC-Leistungskabel anschließen  
**es** Conexión de cables de energía eléctrica de CC  
**fr** Raccordement des câbles de puissance DC  
**it** Nuolatinės srovės galios kabelio prijungimas

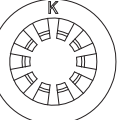
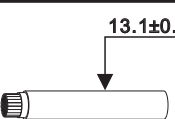

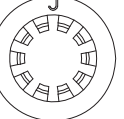
Metal Terminal (M )	DC Power Cable (R )	O -ring (O )	Claw(P )
 70mm <sup>2</sup>	 14.0±0.5 mm		
	 17.0±0.5 mm		
 50mm <sup>2</sup>	 11.9±0.4 mm		
	 14.9±0.4 mm		
 35mm <sup>2</sup>	 10.2±0.3 mm		
	 13.1±0.3 mm		

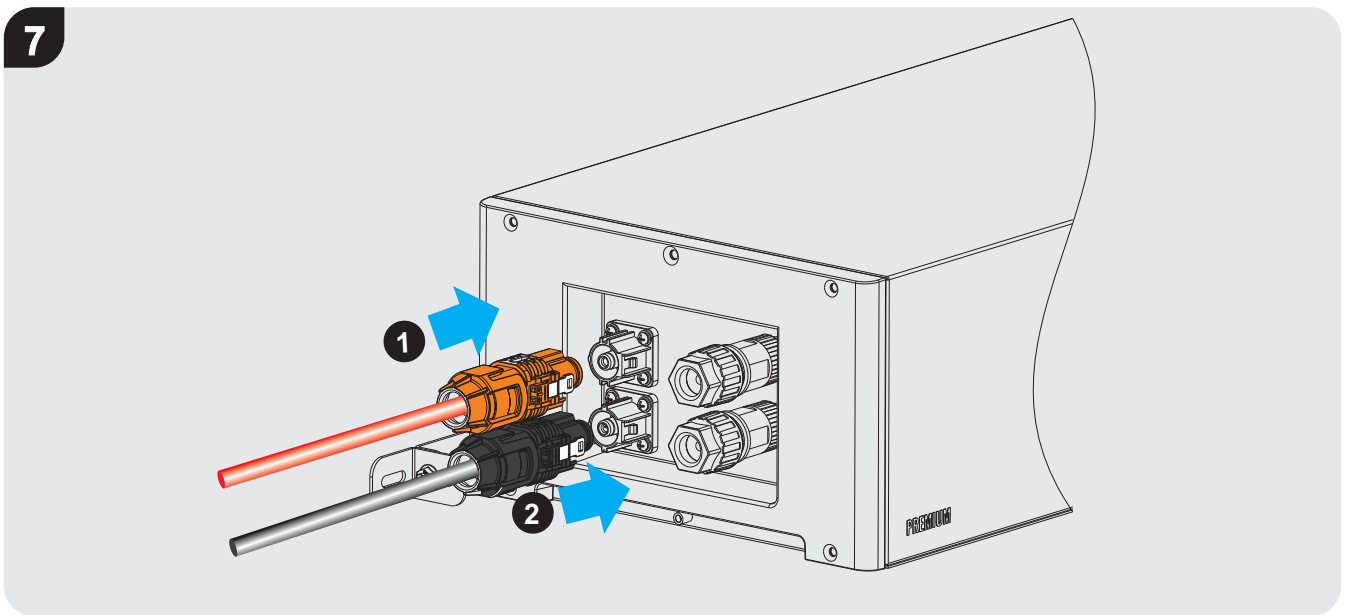
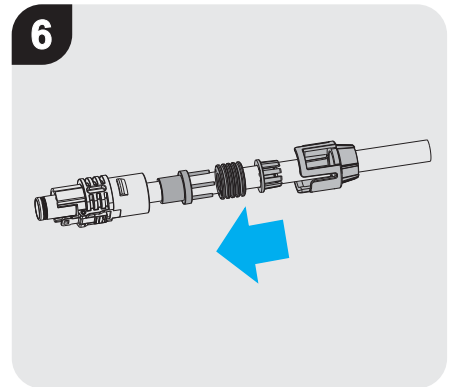
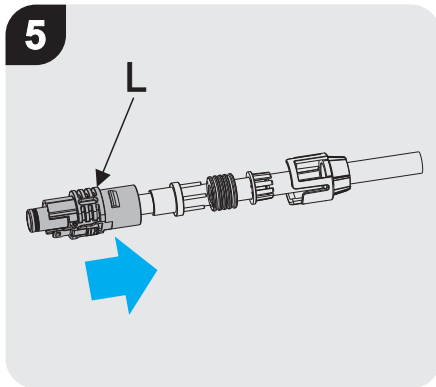
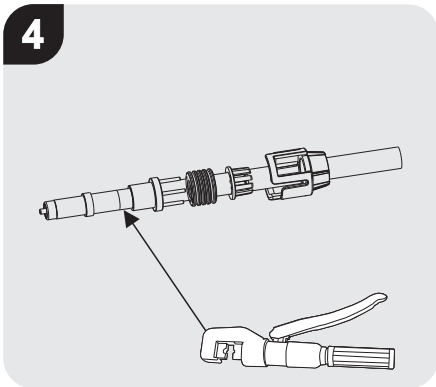
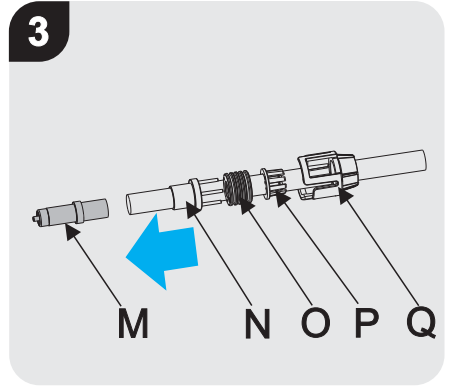
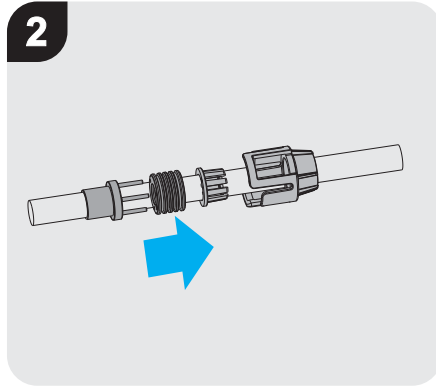
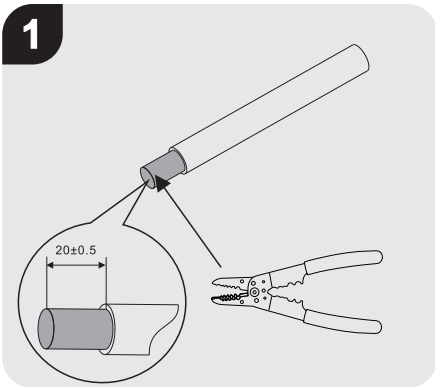



11. **en** Commissioning **de** Kommission **es** comisión **fr** commission **it** commissione

- 11.1 **en** Switch on the Battery System  
**de** Batteriesystem einschalten  
**es** Encienda el sistema de batería  
**fr** Allumez le système de batterie  
**it** Accendere il sistema batteria

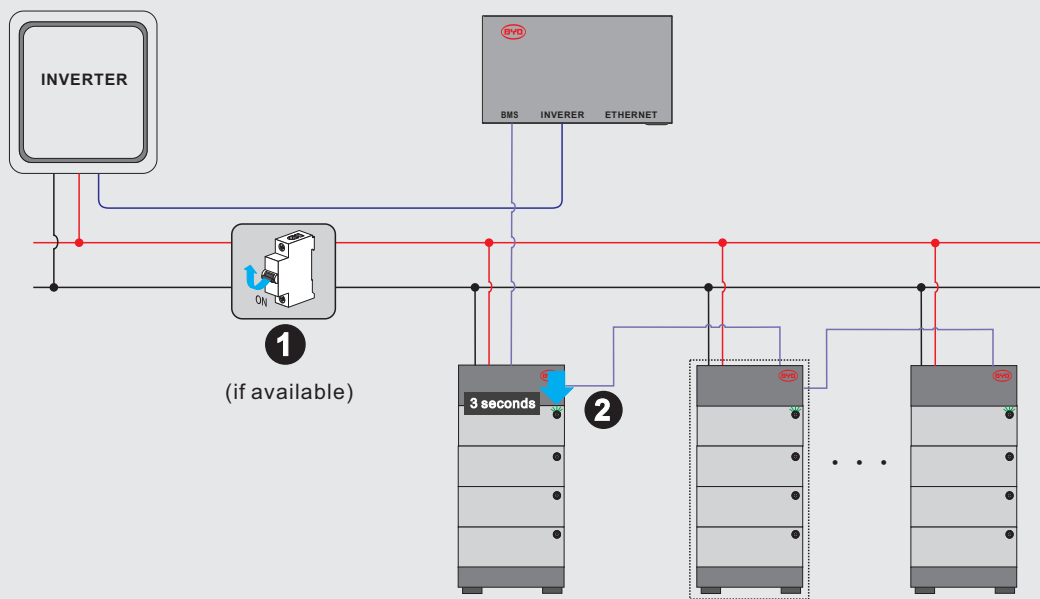

For Australia Market

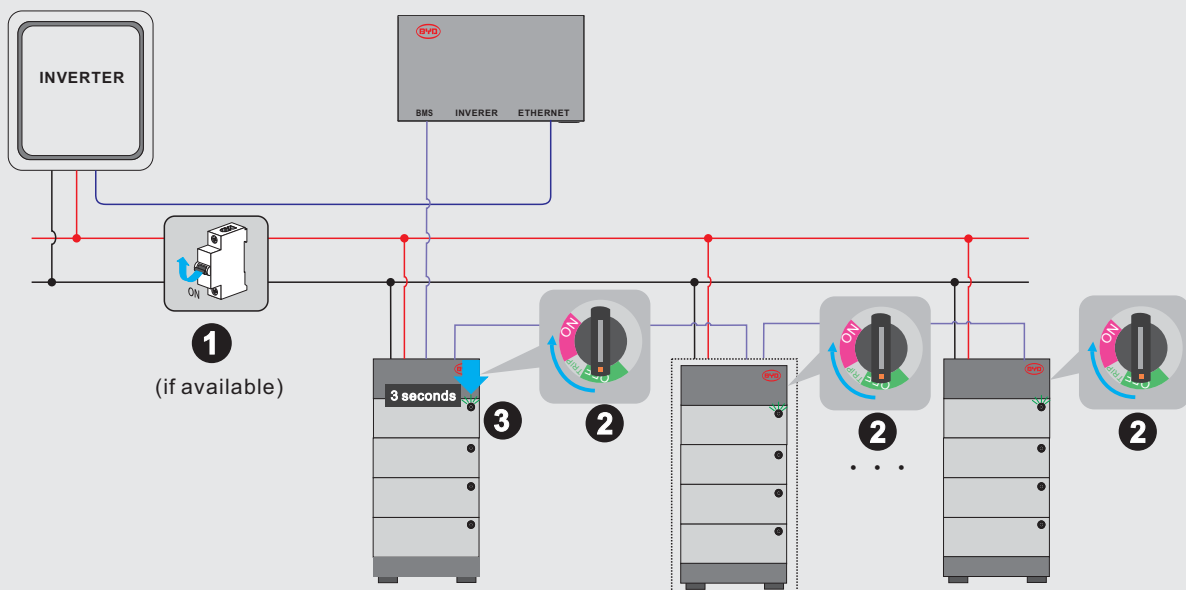



## 11.2 **en** Configuration **de** Konfiguration **es** Configuración **fr** Configuration **it** Configurazione

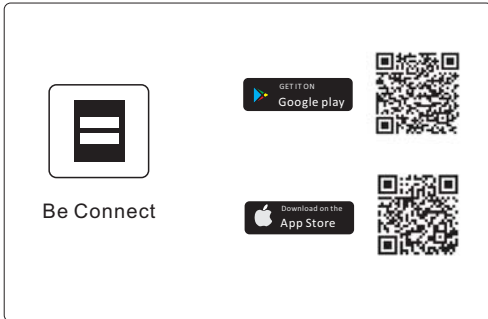

**1**



**2**

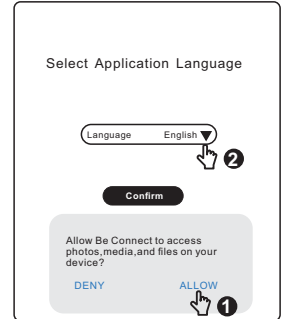

**3**

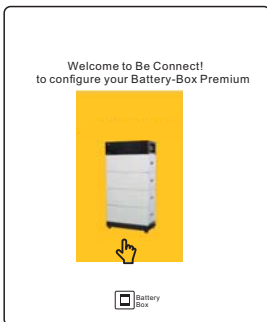

**4**

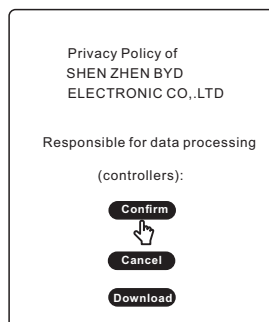

**5**

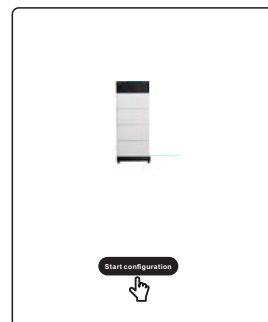

**6**

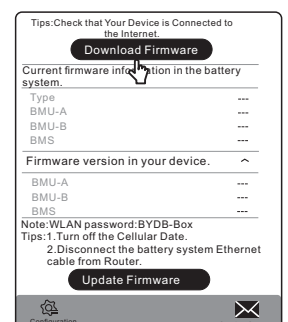

**7**

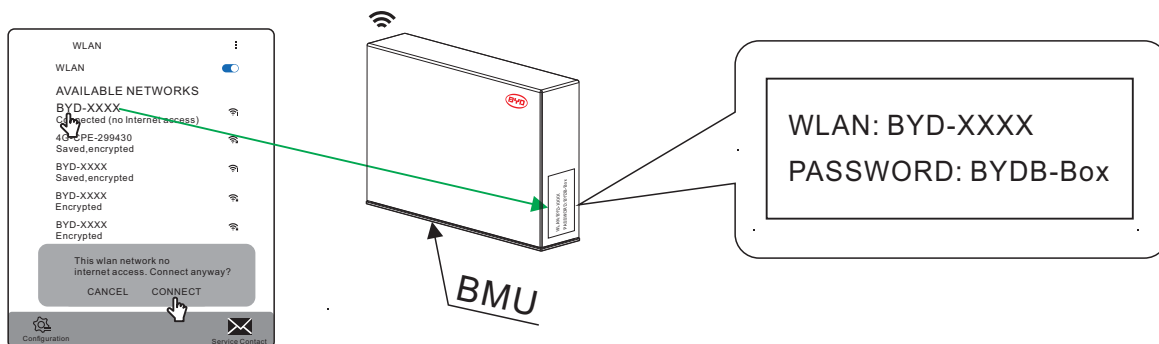

**8**

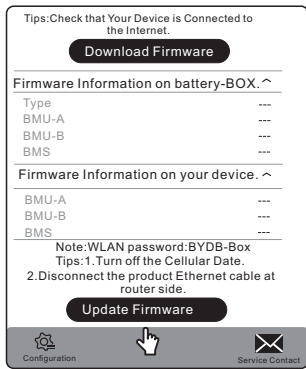

9

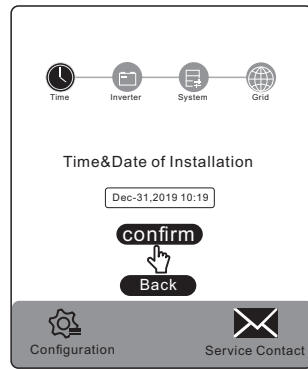

10

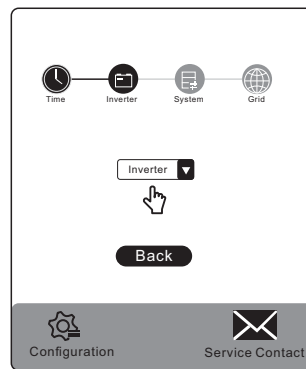

11

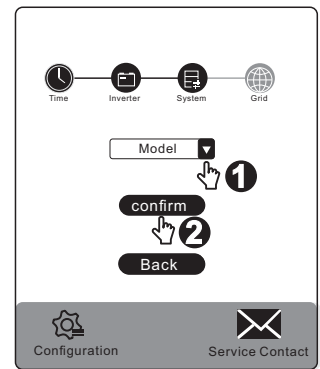

12

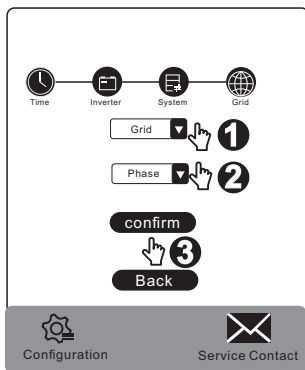

13

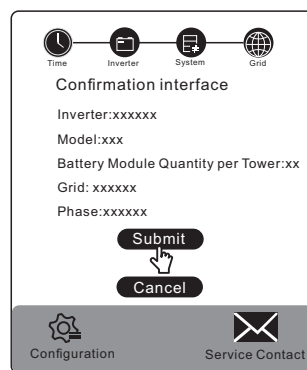

14

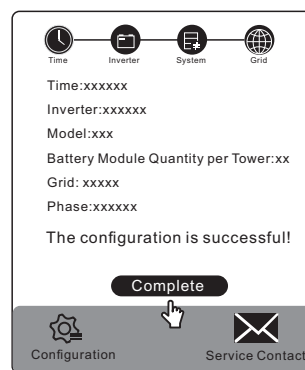

15

11.3 **en** Switch on the Inverter **de** Schalten Sie den Wechselrichter ein  
**es** Encienda el inversor **fr** Allumez l'onduleur **it** Accendere l'inverter

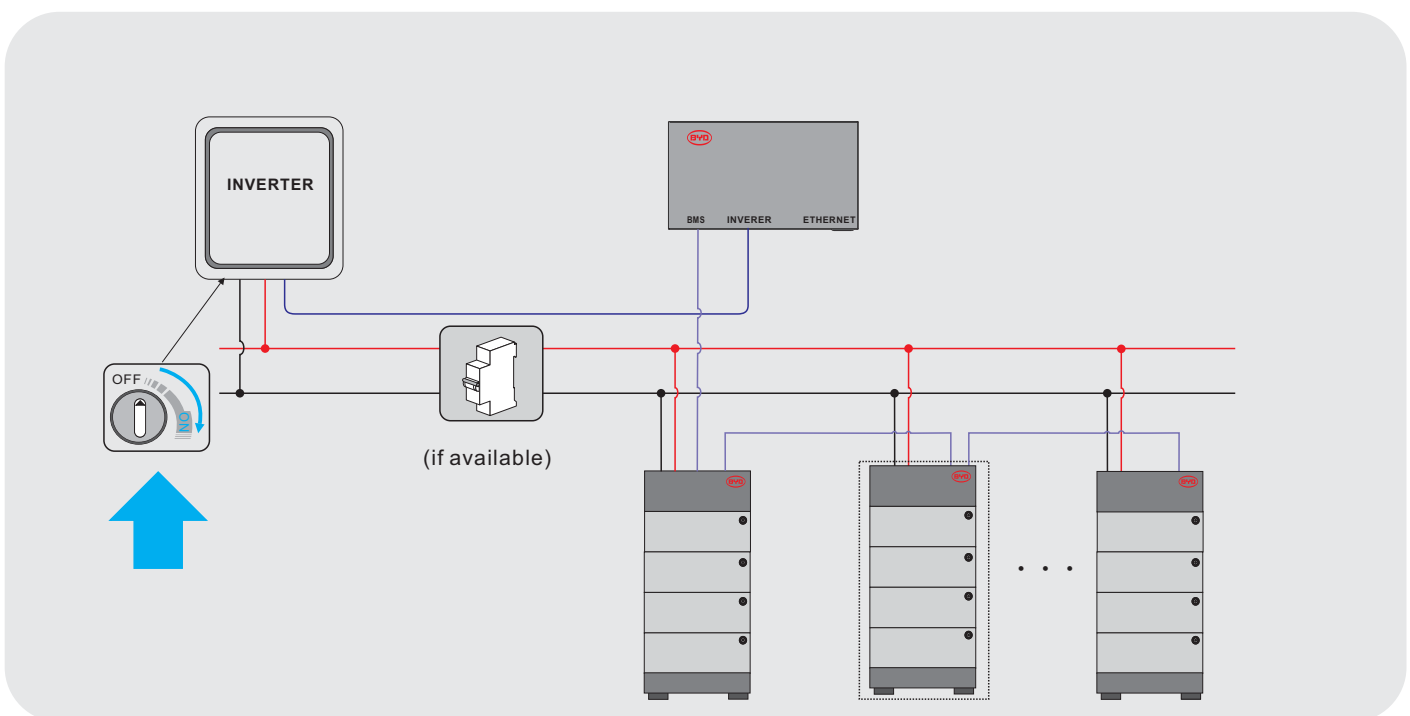



## 12. en Operation de Betrieb es Operación fr Opération it Operazione

### 12.1 en Start Procedure de Verfahren starten es Procedimiento de inicio fr Procédure de démarrage it Avviare la procedura

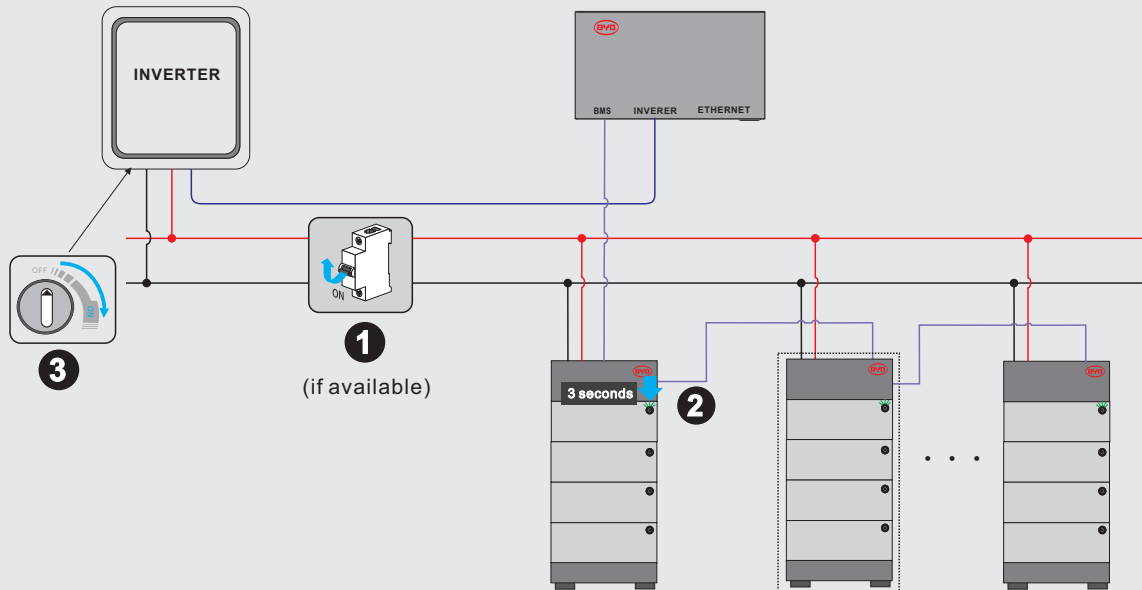

Switch On Process: ① Switch between Battery and Inverter (if available); ② Battery; ③ Inverter

#### For Australia Market

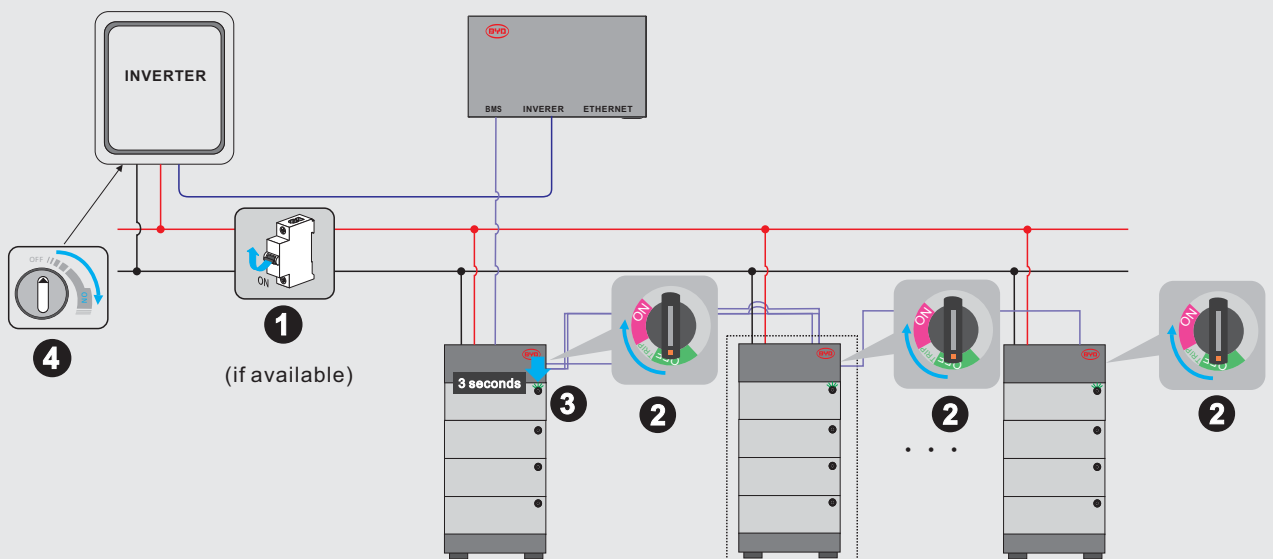

Switch On Process: ① Switch between Battery and Inverter (if available); ② PDU Air Switch ③ Battery; ④ Inverter





12.2 **en** Close Procedure **de** Verfahren schließen **es** Procedimiento cerrado  
**fr** Procédure de fermeture **it** Chiudi procedura

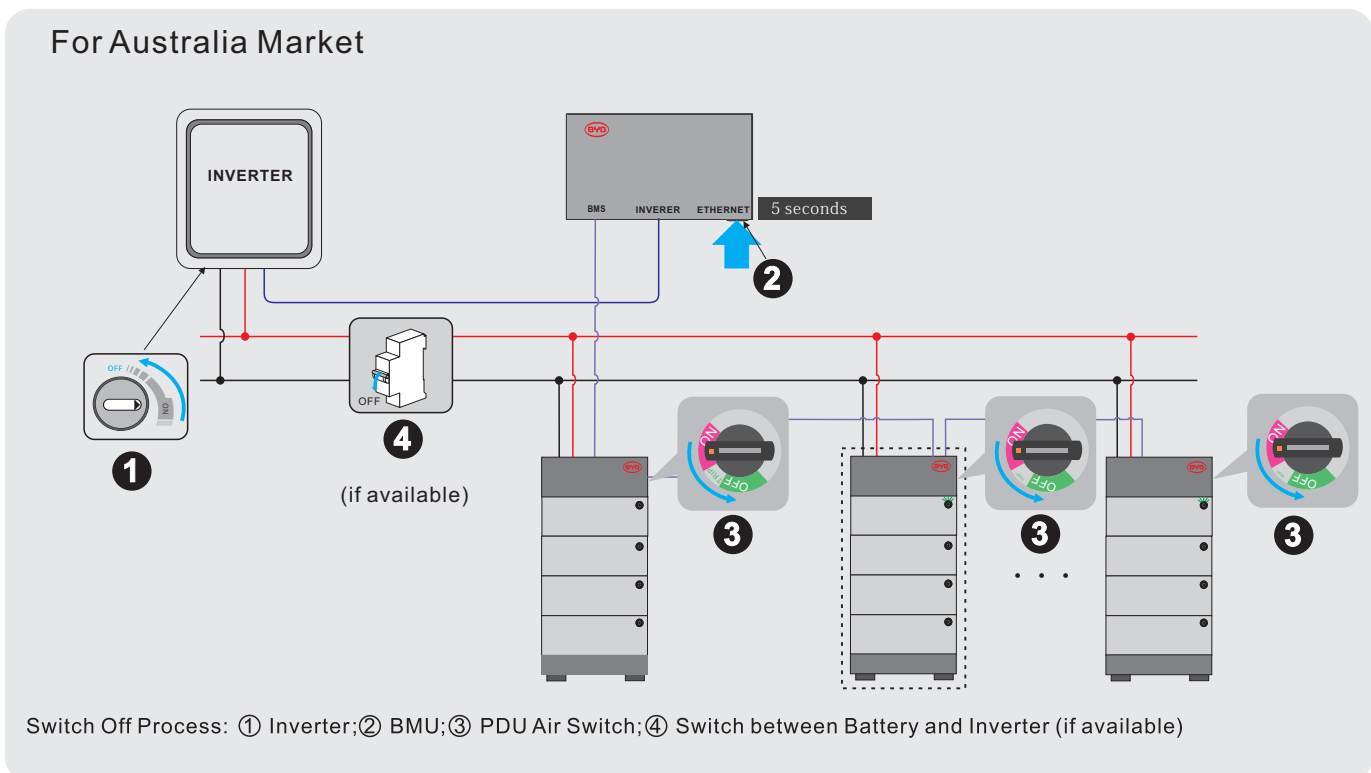
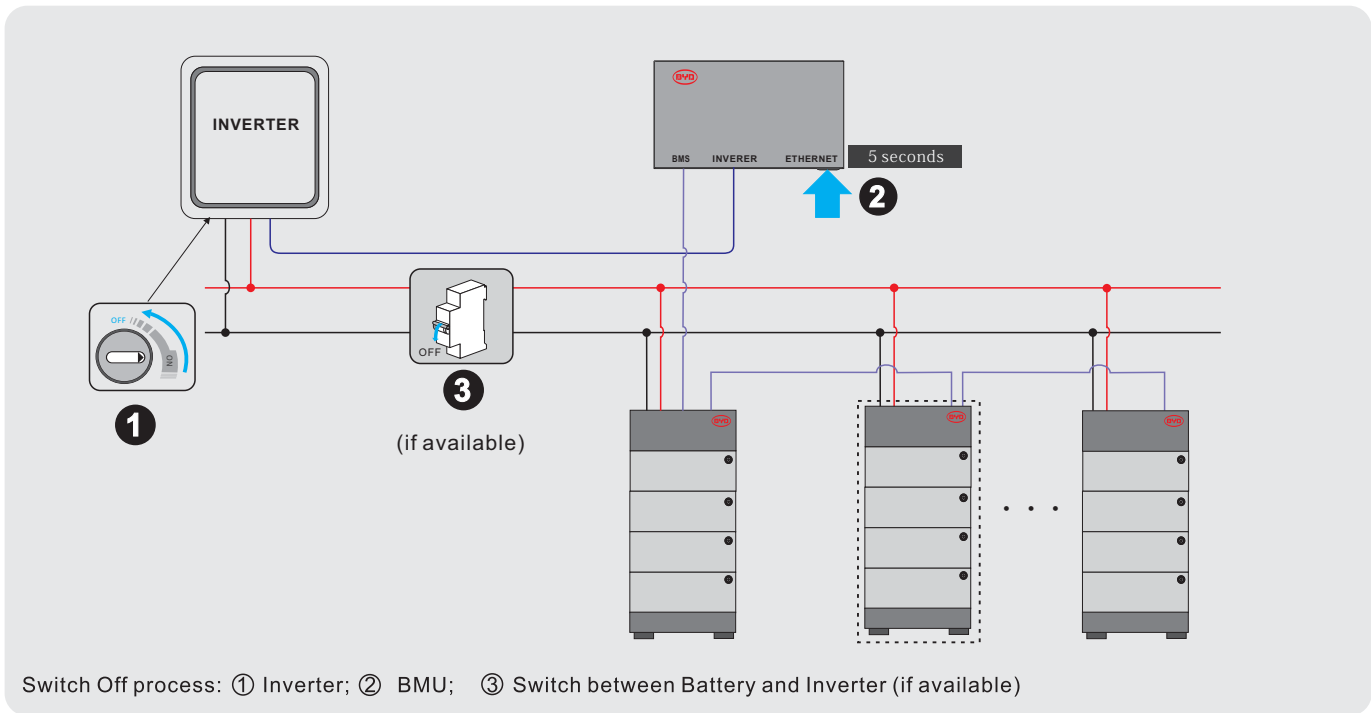



13. **en** Extension **de** Erweiterung **es** Extensión **fr** Extension **it** Estensione

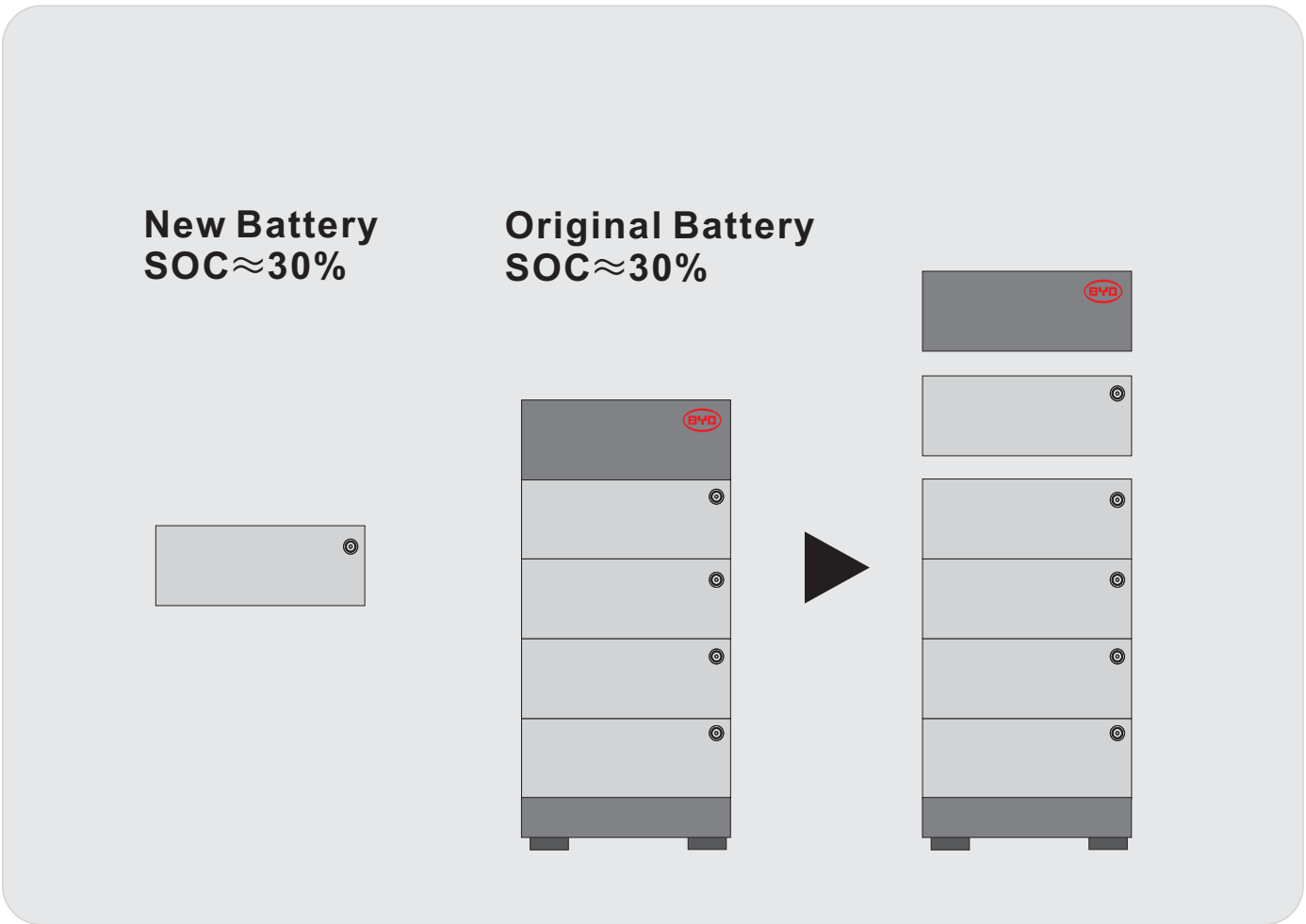



14. **en** LED status **de** LED-Status **es** Estado del LED **fr** État des LED

**it** Stato del LED

Flashing white and blue alternatively

White  ON  
OFF

Blue  ON  
OFF



The battery system is initiating.

Glowing white

White  ON  
OFF

Blue  ON  
OFF

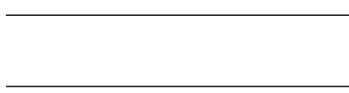

Idle (the battery system is neither charging nor discharging).

Flashing white slowly

White  ON  
OFF

Blue  ON  
OFF

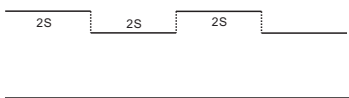

The battery system is charging.

Flashing white quickly

White  ON  
OFF

Blue  ON  
OFF

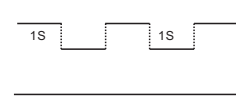

The battery system is discharging.

Flashing white and glowing blue

White  ON  
OFF

Blue  ON  
OFF

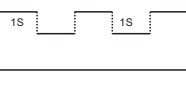

The battery system is discharging, and the SOC of Battery-Box is below 15%.

Flashing white and blue

White  ON  
OFF

Blue  ON  
OFF

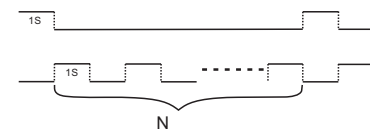

An error has occurred.

Alternativ blinkend weiß und blau

White  ON  
OFF

Blue  ON  
OFF

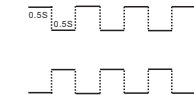

Das Batteriesystem wird gestartet.

Weiß leuchtend

White  ON  
OFF

Blue  ON  
OFF

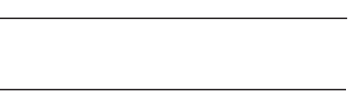

Leerlauf (das Batteriesystem wird weder geladen noch entladen).

Langsam blinkend weiß

White  ON  
OFF

Blue  ON  
OFF

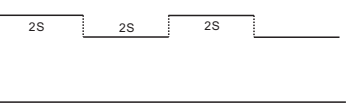

Das Batteriesystem wird aufgeladen.

Weiß schnell blinkend

White  ON  
OFF

Blue  ON  
OFF

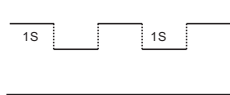

Das Batteriesystem entlädt sich.

Weiß blinkend und blau leuchtend

White  ON  
OFF

Blue  ON  
OFF

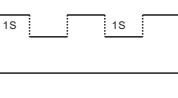

Das Batteriesystem entlädt sich und der Ladezustand der Batteriebox liegt unter 15%.

Weiß und blau blinkend

White  ON  
OFF

Blue  ON  
OFF

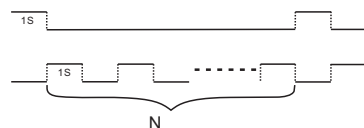

Ein Fehler ist aufgetreten.



Intermitente blanco y azul  
alternativamente

White  ON  
OFF

Blue  ON  
OFF

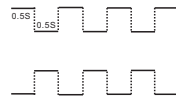

El sistema de batería se está iniciando.

Blanco brillante

White  ON  
OFF

Blue  ON  
OFF

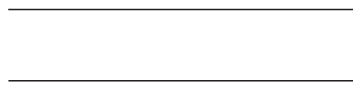

Inactivo (el sistema de batería no se  
está cargando ni descargando).

Parpadeo blanco  
lentamente

White  ON  
OFF

Blue  ON  
OFF

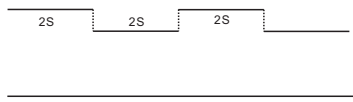

El sistema de batería se está cargando.

Blanco intermitente  
rápidamente

White  ON  
OFF

Blue  ON  
OFF

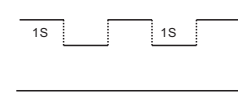

El sistema de batería se está descargando.

Intermitente blanco y azul  
brillante

White  ON  
OFF

Blue  ON  
OFF

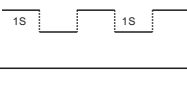

El sistema de batería se está descargando  
y el SOC de Battery-Box está por debajo del 15%.

Intermitente blanco y azul

White  ON  
OFF

Blue  ON  
OFF

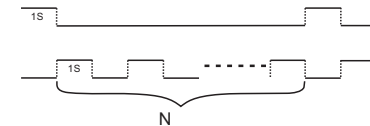

Se ha producido un error.

Clignotant blanc et bleu  
alternativement

White  ON  
OFF

Blue  ON  
OFF

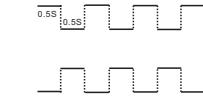

Le système de batterie démarre.

Blanc éclatant

White  ON  
OFF

Blue  ON  
OFF

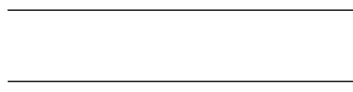

Inactif (le système de batterie ne se  
charge ni ne se décharge).

Clignotant blanc lentement

White  ON  
OFF

Blue  ON  
OFF

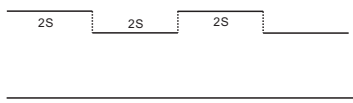

Le système de batterie est en charge.

Blanc clignotant  
rapidement

White  ON  
OFF

Blue  ON  
OFF

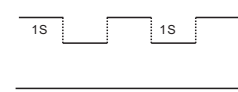

Le système de batterie se décharge.

Blanc clignotant et bleu  
brillant

White  ON  
OFF

Blue  ON  
OFF

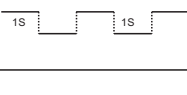

Le système de batterie se décharge et le  
SOC du Battery-Box est inférieur à 15%.

Clignotant blanc et bleu

White  ON  
OFF

Blue  ON  
OFF

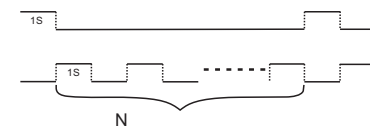

Une erreur est survenue.



Bianco e blu lampeggianti  
alternativamente

White  ON  
OFF

Blue  ON  
OFF



Il sistema batteria si sta avviando.

Bianco incandescente

White  ON  
OFF

Blue  ON  
OFF



Inattivo (il sistema batteria non  
si carica né scarica).

Lampeggiante bianco  
lentamente

White  ON  
OFF

Blue  ON  
OFF

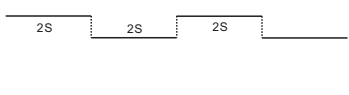

Il sistema della batteria si sta  
caricando.

Bianco lampeggiante  
rapidamente

White  ON  
OFF

Blue  ON  
OFF

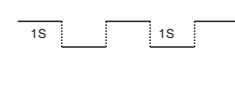

Il sistema della batteria si sta scaricando.

Bianco lampeggiante e blu  
brillante

White  ON  
OFF

Blue  ON  
OFF

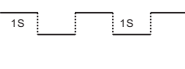

Il sistema della batteria si sta scaricando  
e il SOC del Battery-Box è inferiore al 15%.

Lampeggiante bianco e blu

White  ON  
OFF

Blue  ON  
OFF

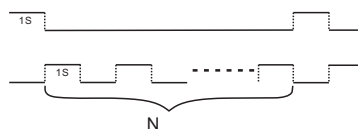

C'è stato un errore.

BYD Global Service

bboxservice@byd.com

Telephone: +86 755 89888888-47175

Address: No.3009, BYD Road,  
Pingshan, Shenzhen, 5118118,  
P.R.China

Website: [www.bydbatterybox.com](http://www.bydbatterybox.com)

Social media link:

<https://www.facebook.com/BatteryBoxBYD/>

[https://twitter.com/BYD\\_BatteryBox](https://twitter.com/BYD_BatteryBox)

<https://www.linkedin.com/company/byd-battery-box>

Australia

Alps Power Pty Ltd

service@alpspower.com.au

Telephone: +61 2 8005 6688

Address: 14/47-51 Lorraine St  
Peakhurst NSW 221

[www.alpspower.com.au](http://www.alpspower.com.au)

Europe

EFT-Systems GmbH

service@eft-systems.de

Telephone: +49 9352 8523999

+44 (0) 2037695998(UK)

+34 91 060 22 67(ES)

+39 02 873683(IT)

Address: Bruchtannenstraße 28, 63801

Kleinostheim, Germany

Website: [www.eft-systems.de](http://www.eft-systems.de)

South  
Africa

AFRIPLUS ENERGY GROUP (PTY) LTD USA

Support@afriplusenergy.co.za

Telephone: +27 21 140 3594

Address: The Pavilion, Corner of  
Dock & Portwood Road, V&A  
WATERFRONT, 8001, CAPE  
TOWN

EFT USA

USservice@eft-systems.de

Telephone: +1(833) 338-8721

Website: [www.eft-systems.de/us](http://www.eft-systems.de/us)